

Spherical Roller Bearings



EVOLMEC ® S.r.l.

Evoluzione Meccanica

All rights reserved. The reproduction, even partial, of the contents of this catalogue is not authorized without our permission.

EVSRB-02/2021, «Spherical Roller Bearings» catalogue, February 2021

Description

Spherical roller bearings have two rows of symmetrical barrel rollers that rotate on a single spherical raceway in the outer ring. The two inner ring raceways are inclined at an angle to the bearing axis.

Because of their high load carrying capacity, spherical roller bearings are ideally suited for applications where extremely high loads have to be accommodated. Moreover, spherical roller bearings can sustain axial forces in both directions, offering an excellent self-aligning capability and are impervious to shaft deflections as well as misalignment of the bearings seats.

Spherical roller bearing are available with cylindrical bore or tapered bore.

Depending on the bearing series, the tapered bore has a taper of 1:12 (suffix K) or a taper of 1:30 (suffix K30)



Spherical roller bearing

Dimensions

The boundary dimensions of the metric bearings identified by standard designations tables conform to ISO 15:2017.

Tolerances

Spherical roller bearings are produced with normal tolerances (P0) as standard or with increased accuracy corresponding to tolerance classes P6 and P5 (where running tolerance is critical). Please contact our technical department to check the availability of bearings to P6 and P5 specifications.

Tolerances values, conform to ISO 492:2014, will be found in the tables from page 8 to page 11.

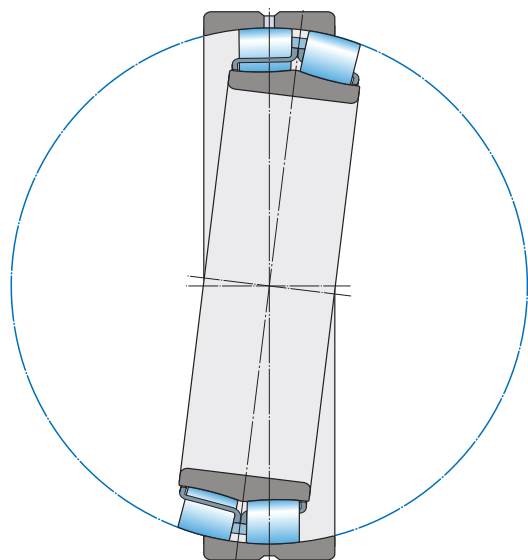

Self-aligning property

Sealing

For bearing arrangements where loads are heavy and operating conditions very arduous, and where particular demands are made with regard to sealing, EVOLMEC can supply spherical roller bearings with fitted with a contact seal, on one or both sides, made of one of the following materials:

- sheet steel reinforced NBR (suffix CS or 2CS)
- sheet steel reinforced FKM (suffix CS2 or 2CS2)
- sheet steel reinforced HNBR (suffix CS5 or 2CS5)

Design

EVOLMEC spherical roller bearings are made to one of the designs described and illustrated in the following, depending on size and series.

CC design

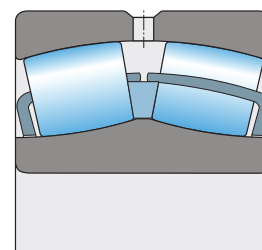

CC

Bearings with CC designation have a flangeless the inner ring, a stamped window-type steel cage for each roller row and a floating guide ring centred on the inner ring.

ECC designation indicate bearings that incorporate reinforced roller sets for increased load carrying capacity.

CA design

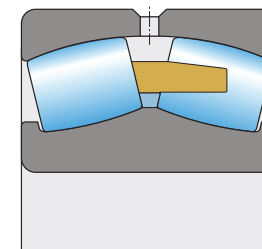

CA

Bearings with CA design have a machined double pronged brass cage, a inner ring with a retaining flange on both sides to keep the rollers in place and a floating guide ring centred on the inner ring. (Fig.2)

ECA designation indicate bearings that incorporate reinforced roller sets for increased load carrying capacity.

Cage design for these bearings can also be specified by adding F (machined steel cage, rolling element centred), FA (machined steel cage, outer ring centred) or MA suffix (machined brass cage, outer ring centred)

E design

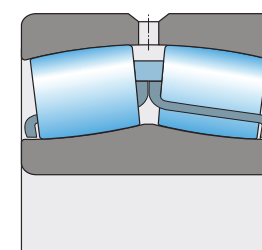

E

Bearings with E design have a flangeless the inner ring, a stamped window-type steel cage for each roller row and a floating guide ring centred on the inner ring or on the cages. These bearings have an optimized internal design for increased load carrying capacity.

Annular groove and lubrication holes

Spherical roller bearings of CC and CA design are available with an annular groove and three lubrication holes in the outer ring (suffix **W33**) or three lubrication holes in the outer ring (suffix **W20**).

E design bearings have an annular groove and three lubrication holes as standard and no suffix is used to identify this feature. If E design bearings are required without this feature, then suffix **W** must be added to the bearing designation.

Please refer to the "Designation System" chapter at page 14 for more details and additional designations.

Misalignment

Spherical roller bearings compensate for angular misalignments.

The permissible adjustment angle is stated for loads $P \leq 0,1 C$, see Tab.1.

Whether these values can be fully exploited or not depends on the design of the bearing arrangement.

Misalignment for sealed bearings should not exceed $0,5^\circ$.

Lubrication

Open spherical roller bearings can be lubricated with oil or grease. Sealed bearings are supplied grease lubricated and should not be washed.

Operating temperature

Spherical roller bearings without seals are dimensionally stable up to $+150^\circ\text{C}$. For use of bearings without deformation of the rings up to higher temperature please refer to paragraph "Material" in the next page where stabilization suffixes are explained. For application at temperatures above $+250^\circ\text{C}$, please contact us.

Permissible angular misalignment	
Bearing series Sizes (d/5)	Permissible angular misalignment
-	°
Series 213	2
Series 222	
Sizes < 52	2
Sizes ≥ 52	1,5
Series 223	3
Series 230	
Sizes < 56	2
Sizes ≥ 56	2,5
Series 231	
Sizes < 60	2
Sizes ≥ 60	3
Series 232	
Sizes < 52	2,5
Sizes ≥ 52	3,5
Series 238	1,5
Series 239	1,5
Series 240	2
Series 241	
Sizes < 64	2,5
Sizes ≥ 64	3,5
Series 248	1,5
Series 249	2,5

Tab.1 - Permissible angular misalignment

For sealed bearings the permissible operating temperature depends on the seal material:

NBR: from -40 to $+90^\circ\text{C}$

HNBR: from -40 to $+150^\circ\text{C}$

FKM: from -30 to $+200^\circ\text{C}$

Operating temperature can be also limited by the lubricant used.

Material

Inner and outer ring material

Spherical roller bearing rings are manufactured in core hardened steel 100Cr6 (UNI 3097 – WNr. 1.3505) or 100CrMn6 (WNr.1.3520) according to the sizes.

On request and for special applications they can be manufactured in case-hardening steel (suffix **HA1**, **HA2** or **HA3**)

Inner and outer ring heat treatment

Performed treatments: annealing (annealing of workability), hardening and tempering.

These treatments will be always performed ensuring the use of bearings without deformations of the rings up to temperatures of 150°C (stabilization **S0**).

On request these treatments can be performed ensuring a final stabilization **S1** or **S2**.

S1 for functioning without deformations of the rings up to 200°C (suffix **S1**) and **S2** for functioning without deformations of the rings up to 250°C (suffix **S2**).

Inner and outer ring hardness

Hardness values for rings are included between 58 and 64 HRc.

Roller material

Spherical roller bearing rollers are manufactured in core hardened steel 100Cr6 (UNI 3097 – WNr. 1.3505) or 100CrMn6 (WNr.1.3520) according to the sizes.

Roller heat treatment

Performed treatments: annealing (annealing of workability), hardening and tempering.

Inner and outer ring hardness

Hardness values for rings are included between 60 and 65 HRc.

Other executions

Please contact **EVOLMEC** technical department for information about executions which are not included in this catalogue.

Radial internal clearance

The values of the clearance limits conform to **ISO 5753-1:2009** for the size range covered by this standard. Radial internal clearance values are valid for unmounted bearings under zero measuring load. Values differ between cylindrical bore bearings and tapered bore bearings.

Tolerances values will be found in the tables from page 12 to page 13.

Normal tolerances for radial bearings, except tapered roller bearings												
Inner ring												
d	> ≤	t _{Admp} ¹⁾		t _{Vdmp} ¹⁾			t _{ΔBs}	t _{VBs}	t _{Kα}	Diameter series		
		U	L	7,8,9 ²⁾	0,1	2,3,4				All	Normal	Modified ³⁾
μm		μm		μm		μm	μm	μm	μm	μm	μm	
-	2,5	0	-8	10	8	6	6	0	-40	-	12	10
2,5	10	0	-8	10	8	6	6	0	-120	-250	15	10
10	18	0	-8	10	8	6	6	0	-120	-250	20	10
18	30	0	-10	13	10	8	8	0	-120	-250	20	13
30	50	0	-12	15	12	9	9	0	-120	-250	20	15
50	80	0	-15	19	19	11	11	0	-150	-380	25	20
80	120	0	-20	25	25	15	15	0	-200	-380	25	25
120	180	0	-25	31	31	19	19	0	-250	-500	30	30
180	250	0	-30	38	38	23	23	0	-300	-500	30	40
250	315	0	-35	44	44	26	26	0	-350	-500	35	50
315	400	0	-40	50	50	30	30	0	-400	-630	40	60
400	500	0	-45	56	56	34	34	0	-450	-	50	65
500	630	0	-50	63	63	38	38	0	-500	-	60	70
630	800	0	-75	-	-	-	-	0	-750	-	70	80
800	1000	0	-100	-	-	-	-	0	-1 000	-	80	90
1000	1250	0	-125	-	-	-	-	0	-1 250	-	100	100
1250	1600	0	-160	-	-	-	-	0	-1 600	-	120	120
1600	2000	0	-200	-	-	-	-	0	-2 000	-	140	140

Normal tolerances for radial bearings, except tapered roller bearings											
Outer ring											
D	> ≤	t _{ADmp}		t _{VDisp} ⁴⁾			t _{VDmp} ⁴⁾	t _{ΔCs} , t _{VCs}	t _{Kα}	Diameter series	
		U	L	7,8,9 ²⁾	0,1	2,3,4				Open Bearings	Sealed bearings
μm		μm		μm		μm	μm	μm	μm	μm	μm
2,5	18	0	-8	10	8	6	10	6	Identical to t _{ΔBs} and t _{VBs} of an inner ring of the same bearing as the outer ring	15	
18	30	0	-9	12	9	7	12	7		15	
30	50	0	-11	14	11	8	16	6		20	
50	80	0	-13	16	13	10	20	8		25	
80	120	0	-15	19	19	11	26	11		35	
120	150	0	-18	23	23	14	30	14		40	
150	180	0	-25	31	31	19	38	19		45	
180	250	0	-30	38	38	23	-	23		50	
250	315	0	-35	44	44	26	-	26		60	
315	400	0	-40	50	50	30	-	30		70	
400	500	0	-45	56	56	34	-	34		80	
500	630	0	-50	63	63	38	-	38		100	
630	800	0	-75	94	94	55	-	55		120	
800	1000	0	-100	125	125	75	-	75		140	
1000	1250	0	-125	-	-	-	-	-		160	
1250	1600	0	-160	-	-	-	-	-	190		
1600	2000	0	-200	-	-	-	-	-	220		
2000	2500	0	-250	-	-	-	-	-	250		

1) Tolerances for tapered bores (tables at page 11)
 2) Diameter series 7 and 8 not covered by ISO 492.
 3) Applies to inner and outer rings of matched bearing sets consisting of two or more bearings. Doesn't apply to universally matchable angular contact ball bearings.
 4) Applies to bearings prior to mounting and after removal of internal or external snap ring.

P6 tolerances for radial bearings, except tapered roller bearings												
Inner ring												
d	> ≤	t _{Admp} ¹⁾		t _{Vdmp} ¹⁾			t _{ΔBs}	t _{VBs}	t _{Kα}	Diameter series		
		U	L	7,8,9 ²⁾	0,1	2,3,4				All	Normal	Modified ³⁾
μm		μm		μm		μm	μm	μm	μm	μm	μm	
-	2,5	0	-7	9	7	5	5	0	-40	-	12	5
2,5	10	0	-7	9	7	5	5	0	-120	-250	15	6
10	18	0	-7	9	7	5	5	0	-120	-250	20	7
18	30	0	-8	10	8	6	6	0	-120	-250	20	8
30	50	0	-10	13	10	8	8	0	-120	-250	20	10
50	80	0	-12	15	15	9	9	0	-150	-380	25	10
80	120	0	-15	19	19	11	11	0	-200	-380	25	13
120	180	0	-18	23	23	14	14	0	-250	-500	30	18
180	250	0	-22	28	28	17	17	0	-300	-500	30	20
250	315	0	-25	31	31	19	19	0	-350	-500	35	25
315	400	0	-30	38	38	23	23	0	-400	-630	40	30
400	500	0	-35	44	44	26	26	0	-450	-	45	35
500	630	0	-40	50	50	30	30	0	-500	-	50	40
630	800	0	-50	-	-	-	-	0	-750	-	60	45
800	1000	0	-60	-	-	-	-	0	-1 000	-	60	50
1000	1250	0	-75	-	-	-	-	0	-1 250	-	70	60
1250	1600	0	-90	-	-	-	-	0	-1 600	-	70	70
1600	2000	0	-115	-	-	-	-	0	-2 000	-	80	80

Normal tolerances for radial bearings, except tapered roller bearings											
Outer ring											
D	> ≤	t _{ADmp}		t _{VDisp} ⁴⁾			t _{VDmp} ⁴⁾	t _{ΔCs} , t _{VCs}	t _{Kα}	Diameter series	
		U	L	7,8,9 ²⁾	0,1	2,3,4				Open Bearings	Sealed bearings
μm		μm		μm		μm	μm	μm	μm	μm	μm
2,5	18	0	-7	9	7	5	9	5	Identical to t _{ΔBs} and t _{VBs} of an inner ring of the same bearing as the outer ring	8	
18	30	0	-8	10	8	6	10	6		9	
30	50	0	-9	11	9	7	13	6		20	
50	80	0	-11	14	11	8	16	8		25	
80	120	0	-13	16	16	10	20	10		18	
120	150	0	-15	19	19	11	25	11		20	
150	180	0	-18	23	23	14	30	14		23	
180	250	0	-20	25	25	15	-	15		25	
250	315	0	-25	31	31	19	-	19		30	
315	400	0	-28	35	35	21	-	21		35	
400	500	0	-33	41	41	25	-	25		40	
500	630	0	-38	48	48	29	-	29		50	
630	800	0	-45	56	56	34	-	34		60	
800	1000	0	-60	75	75	45	-	45		75	
1000	1250	0	-75	-	-	-	-	-		85	
1250	1600	0	-90	-	-	-	-	-	100		
1600	2000	0	-115	-	-	-	-	-	100		
2000	2500	0	-135	-	-	-	-	-	120		

1) Tolerances for tapered bores (tables at page 11)
 2) Diameter series 7 and 8 not covered by ISO 492.
 3) Applies to inner and outer rings of matched bearing sets consisting of two or more bearings. Doesn't apply to universally matchable angular contact ball bearings.
 4) Applies to bearings prior to mounting and after removal of internal or external snap ring.

P5 tolerances for radial bearings, except tapered roller bearings

Inner ring

d	$t_{\Delta dmp}^{(1)}$		$t_{Vdmp}^{(1)}$		t_{Vdmp}	$t_{\Delta Bs}$			t_{VBs}	t_{Kls}	t_{Sd}	$t_{Sls}^{(3)}$	
	>	≤	U	L		Diameter series	All	Normal					Modified ⁽⁴⁾
						U	L	L					
μm	μm		μm		μm	μm	μm	μm	μm	μm	μm	μm	
–	2,5	0	–5	5	4	3	0	–40	–250	5	4	7	7
2,5	10	0	–5	5	4	3	0	–40	–250	5	4	7	7
10	18	0	–5	5	4	3	0	–80	–250	5	4	7	7
18	30	0	–6	6	5	3	0	–120	–250	5	4	8	8
30	50	0	–8	8	6	4	0	–120	–250	5	5	8	8
50	80	0	–9	9	7	5	0	–150	–250	6	5	8	8
80	120	0	–10	10	8	5	0	–200	–380	7	6	9	9
120	180	0	–13	13	10	7	0	–250	–380	8	8	10	10
180	250	0	–15	15	12	8	0	–300	–500	10	10	11	13
250	315	0	–18	18	14	9	0	–350	–500	13	13	13	15
315	400	0	–23	23	18	12	0	–400	–630	15	15	15	20
400	500	0	–28	28	21	14	0	–450	–	18	17	18	23
500	630	0	–35	35	26	18	0	–500	–	20	19	20	25
630	800	0	–45	–	–	–	0	–750	–	26	22	26	30
800	1000	0	–60	–	–	–	0	–1 000	–	32	26	32	30
1000	1250	0	–75	–	–	–	0	–1 250	–	38	30	38	30
1250	1600	0	–90	–	–	–	0	–1 600	–	45	35	45	30
1600	2000	0	–115	–	–	–	0	–2 000	–	55	40	55	30

P5 tolerances for radial bearings, except tapered roller bearings

Outer ring

D	$t_{\Delta Dmp}$		$t_{VDmp}^{(5)}$		t_{VDmp}	$t_{\Delta Cs}$	t_{VCs}	t_{Kcs}	$t_{SD}^{(6)}$	$t_{See}^{(3)}$	
	>	≤	U	L							Diameter series
						U					
μm	μm		μm		μm	μm	μm	μm	μm	μm	
2,5	18	0	–5	5	4	3	Identical to $t_{\Delta Bs}$ of an inner ring of the same bearing as the outer ring	5	5	4	8
18	30	0	–6	6	5	3		5	6	4	8
30	50	0	–7	7	5	4		5	7	4	8
50	80	0	–9	9	7	5		6	8	4	10
80	120	0	–10	10	8	5		8	10	4,5	11
120	150	0	–11	11	8	6		8	11	5	13
150	180	0	–13	13	10	7		8	13	5	14
180	250	0	–15	15	11	8		10	15	5,5	15
250	315	0	–18	18	14	9		11	18	6,5	18
315	400	0	–20	20	15	10		13	20	6,5	20
400	500	0	–23	23	17	12		15	23	7,5	23
500	630	0	–28	28	21	14		18	25	9	25
630	800	0	–35	35	26	18		20	30	10	30
800	1000	0	–50	50	29	25		25	35	12,5	–
1000	1250	0	–63	–	–	–		30	40	15	–
1250	1600	0	–80	–	–	–		35	45	17,5	–
1600	2000	0	–100	–	–	–		38	55	20	–
2000	2500	0	–125	–	–	–		45	65	25	–

1) Tolerances for tapered bores (tables at page 11)
 2) Diameter series 7 and 8 not covered by ISO 492.
 3) Applies to groove ball bearings only, except for self-aligning ball bearings.
 4) Applies to inner and outer rings of matched bearing sets consisting of two or more bearings. Doesn't apply to universally matchable angular contact ball bearings.
 5) No values have been established for sealed bearings.
 6) Tolerance values have become half the values in accordance with the revised ISO standard because SD is defined as perpendicularity of outer ring outside surface axis with respect to datum established from the outer ring face.

Tolerances for tapered bore

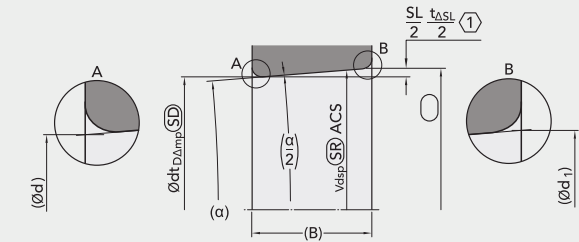

① SL is a calculated nominal size from d and d₁, i.e. $SL = (d_1 - d) = 2B \tan(\alpha/2)$
 ΔSL is a calculated characteristic, i.e. $\Delta SL = \Delta d_{1mp} - \Delta d_{mp}$

Normal, P6 and P5 class tolerances for tapered bores, taper 1:12

Bore diameter		Normal ⁽¹⁾ , P6				P5					
d	≤	$t_{\Delta dmp}$		$t_{Vdmp}^{(2)}$	$t_{\Delta SL}$		$t_{\Delta dmp}$		$t_{Vdmp}^{(2)}$	$t_{\Delta SL}$	
		U	L		U	L	U	L		U	L
μm		μm		μm	μm		μm		μm	μm	
18	30	21	0	13	21	0	13	0	13	13	0
30	50	25	0	15	25	0	16	0	15	16	0
50	80	30	0	19	30	0	19	0	19	19	0
80	120	35	0	22	35	0	22	0	22	22	0
120	180	40	0	31	40	0	25	0	25	25	0
180	250	46	0	38	46	0	29	0	29	29	0
250	315	52	0	44	52	0	32	0	32	32	0
315	400	57	0	50	57	0	36	0	36	36	0
400	500	63	0	56	63	0	40	0	–	40	0
500	630	70	0	70	70	0	44	0	–	44	0
630	800	80	0	–	80	0	50	0	–	50	0
800	1000	90	0	–	90	0	56	0	–	56	0
1000	1250	105	0	–	105	0	66	0	–	66	0
1250	1600	125	0	–	125	0	78	0	–	78	0
1600	2000	150	0	–	150	0	92	0	–	92	0

Normal tolerances for tapered bores, taper 1:30

Bore diameter		Normal				
d	≤	$t_{\Delta dmp}$		$t_{Vdmp}^{(2)}$	$t_{\Delta SL}$	
		U	L		U	L
μm		μm		μm	μm	
–	80	15	0	19	30	0
80	120	20	0	22	35	0
120	180	25	0	40	40	0
180	250	30	0	46	46	0
250	315	35	0	52	52	0
315	400	40	0	57	57	0
400	500	45	0	63	63	0
500	630	50	0	70	70	0
630	800	75	0	–	100	0
800	1000	100	0	–	100	0
1000	1250	125	0	–	115	0
1250	1600	160	0	–	125	0
1600	2000	200	0	–	150	0

1) Smaller tolerance zones than ISO 492.
 2) Applies in any cross section of the bore

Radial internal clearance of spherical roller bearings with cylindrical bore

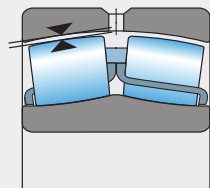

Bore d		Radial internal clearance									
		C2		Normal		C3		C4		C5	
>	≤	min.	max.	min.	max.	min.	max.	min.	max.	min.	max.
mm		μm		μm		μm		μm		μm	
18	24	10	20	20	35	35	45	45	60	60	75
24	30	15	25	25	40	40	55	55	75	75	95
30	40	15	30	30	45	45	60	60	80	80	100
40	50	20	35	35	55	55	75	75	100	100	125
50	65	20	40	40	65	65	90	90	120	120	150
65	80	30	50	50	80	80	110	110	145	145	185
80	100	35	60	60	100	100	135	135	180	180	225
100	100	40	75	75	120	120	160	160	210	210	260
120	140	50	95	95	145	145	190	190	240	240	300
140	160	60	110	110	170	170	220	220	280	280	350
160	180	65	120	120	180	180	240	240	310	310	390
180	200	70	130	130	200	200	260	260	340	340	430
200	225	80	140	140	220	220	290	290	380	380	470
225	250	90	150	150	240	240	320	320	420	420	520
250	280	100	170	170	260	260	350	350	460	460	570
280	315	110	190	190	280	280	370	370	500	500	630
315	355	120	200	200	310	310	410	410	550	550	690
355	400	130	220	220	340	340	450	450	600	600	750
400	450	140	240	240	370	370	500	500	660	660	820
450	500	140	260	260	410	410	550	550	720	720	900
500	560	150	280	280	440	440	600	600	780	780	1.000
560	630	170	310	310	480	480	650	650	850	850	1.100
630	710	190	350	350	530	530	700	700	920	920	1.190
710	800	210	390	390	580	580	770	770	1.010	1.010	1.300
800	900	230	430	430	650	650	860	860	1.120	1.120	1.440
900	1.000	260	480	480	710	710	930	930	1.220	1.220	1.570
1.000	1.120	290	530	530	780	780	1.020	1.020	1.330	1.330	1.720
1.120	1.250	320	580	580	860	860	1.120	1.120	1.460	1.460	1.870
1.250	1.400	350	640	640	950	950	1.240	1.240	1.620	1.620	2.060
1.400	1.600	400	720	720	1.060	1.060	1.380	1.380	1.800	1.800	2.300
1.600	1.800	450	810	810	1.180	1.180	1.550	1.550	2.000	2.000	2.550

Radial internal clearance of spherical roller bearings with tapered bore

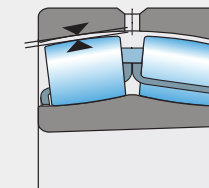

Bore d		Radial internal clearance									
		C2		Normal		C3		C4		C5	
>	≤	min.	max.	min.	max.	min.	max.	min.	max.	min.	max.
mm		μm		μm		μm		μm		μm	
24	30	20	30	30	40	40	55	55	75	-	-
30	40	25	35	35	50	50	65	65	85	85	105
40	50	30	45	45	60	60	80	80	100	100	130
50	65	40	55	55	75	75	95	95	120	120	160
65	80	50	70	70	95	95	120	120	150	150	200
80	100	55	80	80	110	110	140	140	180	180	230
100	120	65	100	100	135	135	170	170	220	220	280
120	140	80	120	120	160	160	200	200	260	260	330
140	160	90	130	130	180	180	230	230	300	300	380
160	180	100	140	140	200	200	260	260	340	340	430
180	200	110	160	160	220	220	290	290	370	370	470
200	225	120	180	180	250	250	320	320	410	410	520
225	250	140	200	200	270	270	350	350	450	450	570
250	280	150	220	220	300	300	390	390	490	490	620
280	315	170	240	240	330	330	430	430	540	540	680
315	355	190	270	270	360	360	470	470	590	590	740
355	400	210	300	300	400	400	520	520	650	650	820
400	450	230	330	330	440	440	570	570	720	720	910
450	500	260	370	370	490	490	630	630	790	790	1.000
500	560	290	410	410	540	540	680	680	870	870	1.100
560	630	320	460	460	600	600	760	760	980	980	1.230
630	710	350	510	510	670	670	850	850	1.090	1.090	1.360
710	800	390	570	570	750	750	960	960	1.220	1.220	1.500
800	900	440	640	640	840	840	1.070	1.070	1.370	1.370	1.690
900	1.000	490	710	710	930	930	1.190	1.190	1.520	1.520	1.860
1.000	1.120	530	770	770	1.030	1.030	1.300	1.300	1.670	1.670	2.050
1.120	1.250	570	830	830	1.120	1.120	1.420	1.420	1.830	1.830	2.250
1.250	1.400	620	910	910	1.230	1.230	1.560	1.560	2.000	2.000	2.450
1.400	1.600	680	1.000	1.000	1.350	1.350	1.720	1.720	2.200	2.200	2.700
1.600	1.800	750	1.110	1.110	1.500	1.500	1.920	1.920	2.400	2.400	2.950

Designation system.

The designation prefixes and suffixes used to identify certain features of bearings listed in the tables, or which are commonly used for spherical roller bearings, are explained in the following.

Prefix

BS2	Spherical roller bearing, special dimensions and/or features
------------	--

Internal design

E	Two stamped window-type steel cages, flangeless inner ring and a floating guide ring centred on the inner ring or on the cages (depending on the bearing size). Optimized internal design for increased load carrying capacity. Annular groove and three lubrication holes in the outer ring
CC	Two stamped window-type steel cages, flangeless inner ring and a floating guide ring centred on the inner ring
ECC	CC design with optimized internal design with reinforced roller sets for increased load carrying capacity
CA	Machined double pronged brass cage, inner ring with a retaining flange on both sides and a floating guide ring centred on the inner ring
ECA	CA design with optimized internal design with reinforced roller sets for increased load carrying capacity

Bore type

-	Cylindrical bore
K	Tapered bore, taper 1:12
K30	Tapered bore, taper 1:30

Cage design

F	Machined steel cage, rolling element centred
FA	Machined steel cage, outer ring centred
MA	Machined brass cage, outer ring centred

Sealing

CS / 2CS	Sheet steel reinforced NBR on one or both sides
CS2 / 2CS2	Sheet steel reinforced FKM on one or both sides
CS5 / 2CS5	Sheet steel reinforced HNBR on one or both sides

Heat treatment

HA1	Case-hardened inner and outer ring
HA2	Case-hardened outer ring
HA3	Case-hardened inner ring

Clearance and accuracy

-	Normal clearance (C0)
C2	Radial internal clearance lower than Normal
C3	Radial internal clearance greater than Normal
C4	Radial internal clearance greater than C3
C5	Radial internal clearance greater than C4
P5	Dimensional and running accuracy to ISO tolerance class 5
P6	Dimensional and running accuracy to ISO tolerance class 6
P62	P6 + C2
C08	Running accuracy to ISO tolerance class 5
C083	C08 + C3
C084	C08 + C4

Stabilization

S1	Rings stabilized for functioning without deformations up to +200°C
S2	Rings stabilized for functioning without deformations up to +250°C

Lubrication

VT143	Filled with SHELL GADUS S3 V220C 2 grease to 25-45%
VT143B	Filled with SHELL GADUS S3 V220C 2 grease to 45-60%
VT143C	Filled with SHELL GADUS S3 V220C 2 grease to 70-100%
W64	Solid Oil
W	Without annular groove and lubrication holes in the outer ring
W20	Three lubrication holes in the outer ring
W26	Six lubrication holes in the inner ring
W33	Annular groove and three lubrication holes in the outer ring
W33X	Annular groove and six lubrication holes in the outer ring
W77	Plugged W33 lubrication holes
W513	W26 + W33

Other features

VA405	Specification for vibrating applications
VA406	VA405 + PTFE-coated cylindrical inner ring bore
VE552(E)	Outer ring with three equally-spaced threaded holes in one side face to accommodate lifting tackle. The E indicates that three appropriate eye bolts are supplied with the bearing
VE553(E)	VE552 but threaded holes in both side faces
VG114	Surface-hardened stamped steel cages
VQ424	Running accuracy better than C08

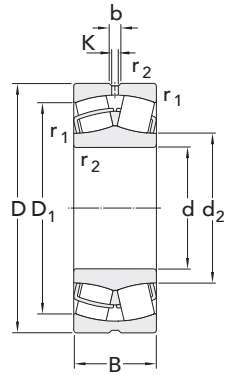

Cylindrical bore

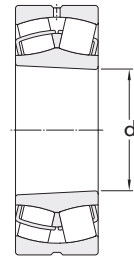

Tapered bore



Sealed

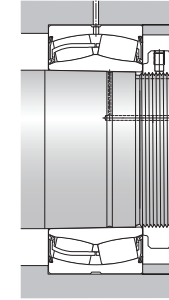
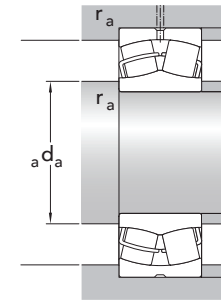

Dimension table

Designation	Main dimensions	Basic load ratings		Fatigue load limit	Speed ratings		Dimensions					Mounting dimensions				Calculation factors				Mass				
		d	D		B	C	C ₀	P _u	Reference speed	Limiting speed	d	d ₂₌	D ₁₌	b	K	r _{1,2} min	d _a min	d _a max	D _a max		r _a max	e	Y ₁	Y ₂
Bearing with cylindrical bore	Bearing with tapered bore	mm			kN		kN	r/min		mm					mm	mm	mm	mm	mm	—				kg
24020.2CS5.VT143	—	100	150	50	294	411	46	—	1.615	100	108	138	6	3	1,5	107	108	143	1,5	0,28	2,4	3,6	2,5	3,15
24020.CC.W33	24020.CC.K30.W33		150	50	294	411	46	2.660	3.800		111	132	6	3	1,5	107	—	143	1,5	0,28	2,4	3,6	2,5	3,15
23120.CC.W33	23120.CC.K.W33		165	52	382	486	53	2.850	3.800		115	144	6	3	2	111	—	154	2	0,3	2,3	3,4	2,2	4,55
23120.2CS5.VT143	—		165	52	383	486	53	—	1.615		112	149	6	3	2	111	112	154	2	0,27	2,5	3,7	2,5	4,55
24120.CC.W33	24120.CC.K30.W33		165	65	464	634	68	2.280	3.040		113	141	4,4	2	2	111	—	154	2	0,37	1,8	2,7	1,8	5,65
24120.2CS5.VT143	—		165	65	466	634	68	—	1.615		110	147	4,4	2	2	110	110	154	2	0,35	1,9	2,9	1,8	5,65
22220.E	22220.EK		180	46	429	486	49	3.230	4.275		118	159	8,3	4,5	2,1	112	—	168	2	0,24	2,8	4,2	2,8	4,9
BS2.2220.2CS5.VT143	BS2.2220.2CS5K.VT143		180	55	429	486	49	—	1.520		114	163	8,3	4,5	2,1	112	114	168	2	0,24	2,8	4,2	2,8	5,5
23220.CC.W33	23220.CC.K.W33		180	60,3	494	594	63	2.280	3.230		117	153	8,3	4,5	2,1	112	—	168	2	0,33	2	3	2	6,85
23220.2CS.VT143	—		180	60,3	495	594	63	—	1.520		114	159	8,3	4,5	2,1	112	114	168	2	0,3	2,3	3,4	2,2	6,85
23220.2CS5.VT143	—		180	60,3	495	594	63	—	1.520		114	159	8,3	4,5	2,1	112	114	168	2	0,3	2,3	3,4	2,2	6,85
21320.E	21320.EK		215	47	429	486	49	3.230	4.275		118	159	8,3	4,5	3	114	—	201	2,5	0,24	2,8	4,2	2,8	8,6
22320.E	22320.EK		215	73	839	941	88	2.280	2.850		130	184	11,1	6	3	114	—	201	2,5	0,33	2	3	2	13,5
23022.2CS.VT143	—	110	170	45	323	436	47	—	1.425	110	122	156	6	3	2	119	122	161	2	0,21	3,2	4,8	3,2	3,8
23022.CC.W33	23022.CC.K.W33		170	45	323	436	47	3.230	4.085		125	151	6	3	2	119	—	161	2	0,23	2,9	4,4	2,8	3,8
24022.CC.W33	24022.CC.K30.W33		170	60	433	614	67	2.280	3.420		122	149	5,5	3	2	119	—	161	2	0,33	2	3	2	5
24022.2CS5.VT143	—		170	60	434	614	67	—	1.520		120	154	6	3	2	119	120	161	2	0,3	2,3	3,4	2,2	5
23122.CC.W33	23122.CC.K.W33		180	56	446	580	61	2.660	3.420		126	157	8,3	4,5	2	121	—	169	2	0,3	2,3	3,4	2,2	5,75
23122.2CS5.VT143	23122.2CS5K.VT143		180	56	447	580	61	—	760		122	166	8,3	4,5	2	121	122	169	2	0,27	2,5	3,7	2,5	5,75
24122.CC.W33	24122.CC.K30.W33		180	69	534	743	78	1.900	2.850		123	153	6	3	2	121	—	169	2	0,37	1,8	2,7	1,8	7,1
24122.2CS5.VT143	—		180	69	535	743	78	—	599		120	163	6	3	2	121	121	169	2	0,35	1,9	2,9	1,8	7,1
22222.E	22222.EK		200	53	567	634	63	2.850	3.800		130	178	8,3	4,5	2,1	122	—	188	2	0,25	2,7	4	2,5	7
BS2.2222.2CS5.VT143	BS2.2222.2CS5K.VT143		200	63	567	634	63	—	1.425		126	183	8,3	4,5	2,1	122	126	188	2	0,25	2,7	4	2,5	7,6
23222.CC.W33	23222.CC.K.W33		200	69,8	620	758	76	2.090	3.040		130	169	8,3	4,5	2,1	122	—	188	2	0,33	2	3	2	9,85
23222.2CS5.VT143	23222.2CS5K.VT143		200	69,8	621	758	76	—	608		126	178	8,3	4,5	2,1	122	126	188	2	0,33	2	3	2	9,85
22322.E	22322.EK		240	80	980	1.109	99	1.900	2.660		143	204	13,9	7,5	3	124	—	226	2,5	0,33	2	3	2	18,5

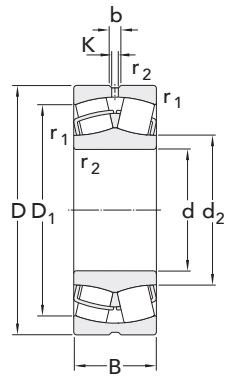

Cylindrical bore

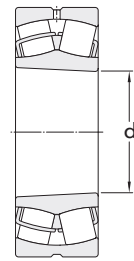

Tapered bore



Sealed

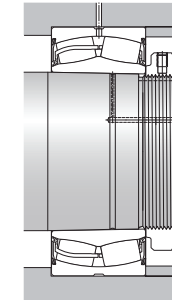
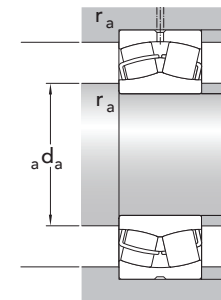

Dimension table

Designation	Main dimensions	Basic load ratings		Fatigue load limit	Speed ratings		Dimensions					Mounting dimensions				Calculation factors			Mass						
		C	C ₀		P _u	Reference speed	Limiting speed	d	d ₂₌	D ₁₌	b	K	r _{1,2} min	d _a min	d _a max	D _a max	r _a max	e		Y ₁	Y ₂	Y ₀			
Bearing with cylindrical bore	Bearing with tapered bore	d	D	B	C	C ₀	P _u	Reference speed	Limiting speed	d	d ₂₌	D ₁₌	b	K	r _{1,2} min	d _a min	d _a max	D _a max	r _a max	e	Y ₁	Y ₂	Y ₀	kg	
–	–	mm	mm	mm	kN	kN	kN	r/min	r/min	mm	mm	mm	mm	mm	mm	mm	mm	mm	mm	–	–	–	–	–	
23024.CC.W33	23024.CC.K.W33	120	180	46	363	495	52	3.040	3.800	120	135	163	6	3	2	129	–	171	2	0,22	3	4,6	2,8	4,2	
23024.2CS5.VT143	–	–	180	46	364	495	52	–	1.330	–	132	168	6	3	2	129	132	171	2	0,2	3,4	5	3,2	4,2	
24024.CC.W33	24024.CC.K30.W33	–	180	60	452	664	68	2.280	3.230	–	132	159	6	3	2	129	–	171	2	0,3	2,3	3,4	2,2	5,45	
24024.2CS5.VT143	–	–	180	60	453	664	68	–	637	–	130	166	6	3	2	129	130	171	2	0,28	2,4	3,6	2,5	5,45	
23124.CC.W33	23124.CC.K.W33	–	200	62	529	689	71	2.470	3.230	–	139	174	8,3	4,5	2	131	–	189	2	0,28	2,4	3,6	2,5	8	
23124.2CS5.VT143	–	–	200	62	530	689	71	–	684	–	135	183	8,3	4,5	2	131	135	189	2	0,27	2,5	3,7	2,5	7,55	
24124.CC.W33	24124.CC.K30.W33	–	200	80	673	941	95	1.805	2.470	–	135	168	6	3	2	131	–	189	2	0,37	1,8	2,7	1,8	10,5	
24124.2CS5.VT143	–	–	200	80	674	941	95	–	532	–	132	179	6	3	2	131	132	189	2	0,37	1,8	2,7	1,8	10,5	
22224.E	22224.EK	–	215	58	646	758	73	2.660	3.610	–	141	189	11,1	6	2,1	132	–	203	2	0,26	2,6	3,9	2,5	8,7	
BS2.2224.2CS5.VT143	BS2.2224.2CS5K.VT143	–	215	69	646	758	73	–	1.330	–	136	194	11,1	6	2,1	132	136	203	2	0,26	2,6	3,9	2,5	9,75	
23224.CC.W33	23224.CC.K.W33	–	215	76	725	921	93	1.900	2.660	–	141	182	8,3	4,5	2,1	132	–	203	2	0,35	1,9	2,9	1,8	12	
23224.2CS5.VT143	23224.2CS5K.VT143	–	215	76	727	921	93	–	570	–	137	193	8,3	4,5	2,1	132	137	203	2	0,33	2	3	2	12	
22324.CC.W33	22324.CC.K.W33	–	260	86	1.009	1.109	99	1.900	2.470	–	152	216	13,9	7,5	3	134	–	246	2,5	0,35	1,9	2,9	1,8	23	
22324.2CS5.VT143	22324.2CS5K.VT143	–	260	86	1.012	1.109	99	–	570	–	147	229	13,9	7,5	3	134	147	246	2,5	0,33	2	3	2	23	
23026.CC.W33	23026.CC.K.W33	–	130	200	52	448	604	61	2.660	3.420	130	148	180	8,3	4,5	2	139	–	191	2	0,23	2,9	4,4	2,8	6
23026.2CS5.VT143	23026.2CS5K.VT143	–	200	52	448	604	62	–	760	–	145	186	8,3	4,5	2	139	145	191	2	0,21	3,2	4,8	3,2	6	
24026.CC.W33	24026.CC.K30.W33	–	200	69	564	807	81	1.900	2.850	–	145	175	6	3	2	139	–	191	2	0,31	2,2	3,3	2,2	8,05	
24026.2CS5.VT143	–	–	200	69	565	822	81	–	570	–	140	183	6	3	2	139	140	191	2	0,3	2,3	3,4	2,2	8,05	
23126.CC.W33	23126.CC.K.W33	–	210	64	581	773	78	2.280	3.040	–	148	184	8,3	4,5	2	141	–	199	2	0,28	2,4	3,6	2,5	8,8	
24126.CC.W33	24126.CC.K30.W33	–	210	80	693	990	99	1.615	2.280	–	146	180	6	3	2	141	–	199	2	0,35	1,9	2,9	1,8	11	
24126.2CS5.VT143	–	–	210	80	694	990	99	–	570	–	141	190	6	3	2	141	141	199	2	0,33	2	3	2	11	
22226.E	22226.EK	–	230	64	751	921	88	2.470	3.420	–	152	201	11,1	6	3	144	–	216	2,5	0,27	2,5	3,7	2,5	11	
BS2.2226.2CS5.VT143	BS2.2226.2CS5K.VT143	–	230	75	751	921	88	–	665	–	147	205	11,1	6	3	144	147	216	2,5	0,27	2,5	3,7	2,5	11	
23226.CC.W33	23226.CC.K.W33	–	230	80	818	1.050	103	1.805	2.470	–	151	196	8,3	4,5	3	144	–	216	2,5	0,33	2	3	2	14,5	
23226.2CS5.VT143	23226.2CS5K.VT143	–	230	80	820	1.050	103	–	504	–	147	209	8,3	4,5	3	144	147	216	2,5	0,31	2,2	3,3	2,2	14,5	
22326.CC.W33	22326.CC.K.W33	–	280	93	1.165	1.307	113	1.710	2.280	–	164	233	16,7	9	4	147	–	263	3	0,35	1,9	2,9	1,8	29	
22326.2CS5.VT143	22326.2CS5K.VT143	–	280	93	1.167	1.307	113	–	475	–	159	246	16,7	9	4	147	159	263	3	0,33	2	3	2	29	

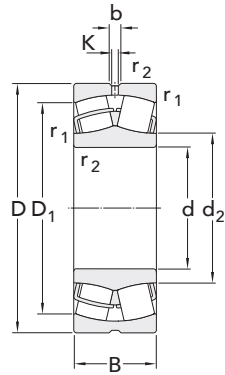

Cylindrical bore

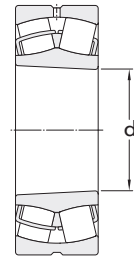

Tapered bore

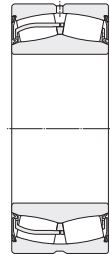

Sealed

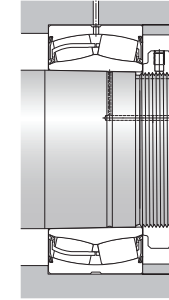
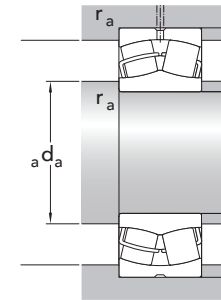

Dimension table

Designation	Main dimensions	Basic load ratings		Fatigue load limit	Speed ratings		Dimensions						Mounting dimensions				Calculation factors			Mass				
		d	D		B	C	C ₀	P _u	Reference speed	Limiting speed	d	d ₂₌	D ₁₌	b	K	r _{1,2} min	d _a min	d _a max	D _a max		r _a max	e	Y ₁	Y ₂
Bearing with cylindrical bore	Bearing with tapered bore	mm			kN		kN	r/min		mm					mm	mm	mm	mm	mm	—				kg
23028.2CS5.VT143	23028.2CS5K.VT143	140	210	53	481	674	68	—	665	140	155	197	8,3	4,5	2	149	155	201	2	0,2	3,4	5	3,2	6,55
23028.CC.W33	23028.CC.K.W33		210	53	481	674	68	2.470	3.230		158	190	8,3	4,5	2	149	—	201	2	0,22	3	4,6	2,8	6,55
24028.CC.W33	24028.CC.K30.W33		210	69	594	891	88	1.900	2.660		155	185	6	3	2	149	—	201	2	0,3	2,3	3,4	2,2	8,55
24028.2CS5.VT143	—		210	69	595	891	88	—	532		151	195	6	3	2	149	151	201	2	0,28	2,4	3,6	2,5	8,55
23128.CC.W33	23128.CC.K.W33		225	68	653	891	88	2.090	2.660		159	197	8,3	4,5	2,1	152	—	213	2	0,28	2,4	3,6	2,5	10,5
24128.CC.W33	24128.CC.K30.W33		225	85	789	1.149	111	1.520	2.090		156	193	8,3	4,5	2,1	152	—	213	2	0,35	1,9	2,9	1,8	13,5
24128.2CS5.VT143	24128.2CS5K30.VT143		225	85	790	1.149	111	—	428		153	203	8,3	4,5	2,1	152	153	213	2	0,35	1,9	2,9	1,8	13,5
22228.CC.W33	22228.CC.K.W33		250	68	736	891	86	2.280	3.040		166	216	11,1	6	3	154	—	236	2,5	0,26	2,6	3,9	2,5	14
22228.2CS5.VT143	22228.2CS5K.VT143		250	68	737	891	86	—	637		161	225	11,1	6	3	154	161	236	2,5	0,24	2,8	4,2	2,8	14
23228.CC.W33	23228.CC.K.W33		250	88	953	1.238	119	1.615	2.280		165	212	11,1	6	3	154	—	236	2,5	0,33	2	3	2	19
23228.2CS5.VT143	23228.2CS5K.VT143		250	88	954	1.238	119	—	456		161	225	11,1	6	3	154	161	236	2,5	0,33	2	3	2	19
22328.CC.W33	22328.CC.K.W33		300	102	1.344	1.545	131	1.615	2.090		175	247	16,7	9	4	157	—	283	3	0,35	1,9	2,9	1,8	36,5
22328.2CS5.VT143	22328.2CS5K.VT143		300	102	1.346	1.545	131	—	409		169	261	16,7	9	4	157	169	283	3	0,33	2	3	2	36,5
23030.CC.W33	23030.CC.K.W33	150	225	56	526	743	73	2.280	3.040	150	169	203	8,3	4,5	2,1	161	—	214	2	0,22	3	4,6	2,8	7,95
23030.2CS5.VT143	23030.2CS5K.VT143		225	56	527	743	73	—	637		165	211	8,3	4,5	2,1	161	165	214	2	0,2	3,4	5	3,2	7,95
24030.CC.W33	24030.CC.K30.W33		225	75	674	1.030	99	1.710	2.470		165	197	6	3	2,1	161	—	214	2	0,3	2,3	3,4	2,2	10,5
24030.2CS5.VT143	—		225	75	675	1.030	99	—	504		162	206	6	3	2,1	161	162	214	2	0,28	2,4	3,6	2,5	10,5
23130.CC.W33	23130.CC.K.W33		250	80	875	1.188	113	1.900	2.470		172	216	11,1	6	2,1	162	—	238	2	0,3	2,3	3,4	2,2	16
23130.2CS5.VT143	23130.2CS5K.VT143		250	80	876	1.188	113	—	532		168	226	11,1	6	2,1	162	168	238	2	0,28	2,4	3,6	2,5	16
24130.CC.W33	24130.CC.K30.W33		250	100	1.044	1.515	145	1.330	1.900		169	211	8,3	4,5	2,1	162	—	238	2	0,37	1,8	2,7	1,8	20
24130.2CS5.VT143	24130.2CS5K30.VT143		250	100	1.046	1.515	145	—	380		163	222	8,3	4,5	2,1	162	163	238	2	0,37	1,8	2,7	1,8	20
22230.CC.W33	22230.CC.K.W33		270	73	890	1.070	101	2.090	2.850		178	234	13,9	7,5	3	164	—	256	2,5	0,26	2,6	3,9	2,5	18
22230.2CS5.VT143	22230.2CS5K.VT143		270	73	891	1.070	101	—	599		174	248	13,9	7,5	3	164	174	256	2,5	0,24	2,8	4,2	2,8	18
23230.CC.W33	23230.CC.K.W33		270	96	1.118	1.446	136	1.520	2.090		175	228	11,1	6	3	164	—	256	2,5	0,35	1,9	2,9	1,8	24,5
23230.2CS5.VT143	23230.2CS5K.VT143		270	96	1.121	1.446	136	—	409		171	243	11,1	6	3	164	171	256	2,5	0,33	2	3	2	24,5
22330.CC.W33	22330.CC.K.W33		320	108	1.524	1.743	145	1.520	1.900		188	266	16,7	9	4	167	—	303	3	0,35	1,9	2,9	1,8	43,5
22330.2CS5.VT143	22330.2CS5K.VT143		320	108	1.526	1.743	145	—	380		181	281	16,7	9	4	167	181	303	3	0,33	2	3	2	43,5

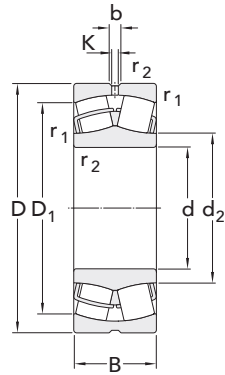

Cylindrical bore

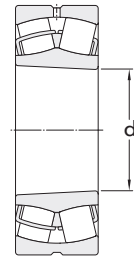

Tapered bore

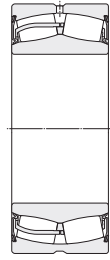

Sealed

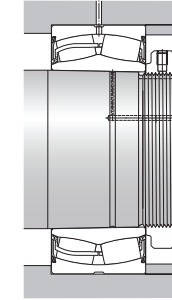
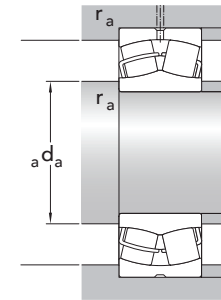

Dimension table

Designation	Main dimensions	Basic load ratings		Fatigue load limit	Speed ratings		Dimensions						Mounting dimensions				Calculation factors			Mass				
		d	D		B	C	C ₀	P _u	Reference speed	Limiting speed	d	d ₂₌	D ₁₌	b	K	r _{1,2} min	d _a min	d _a max	D _a max		r _a max	e	Y ₁	Y ₂
Bearing with cylindrical bore	Bearing with tapered bore	mm			kN		kN	r/min		mm						mm								kg
23032.CC.W33	23032.CC.K.W33	160	240	60	608	872	83	2.280	2.850	160	180	217	11,1	6	2,1	171	—	229	2	0,22	3	4,6	2,8	9,7
23032.2CS5.VT143	23032.2CS5K.VT143		240	60	609	872	83	—	637		177	225	11,1	6	2,1	171	177	229	2	0,2	3,4	5	3,2	9,7
24032.CC.W33	24032.CC.K30.W33		240	80	776	1.188	113	1.615	2.280		176	211	8,3	4,5	2,1	171	—	229	2	0,3	2,3	3,4	2,2	13
24032.2CS5.VT143	—		240	80	777	1.188	113	—	428		173	218	8,3	4,5	2,1	171	173	229	2	0,28	2,4	3,6	2,5	13
23132.CC.W33	23132.CC.K.W33		270	86	1.019	1.357	128	1.805	2.280		184	234	13,9	7,5	2,1	172	—	258	2	0,3	2,3	3,4	2,2	20,5
23132.2CS5.VT143	23132.2CS5K.VT143		270	86	1.020	1.386	128	—	504		180	244	13,9	7,5	2,1	172	180	258	2	0,28	2,4	3,6	2,5	20,5
24132.CC.W33	24132.CC.K30.W33		270	109	1.215	1.743	162	1.235	1.805		181	228	8,3	4,5	2,1	172	—	258	2	0,4	1,7	2,5	1,6	25
24132.2CS5.VT143	—		270	109	1.217	1.743	162	—	361		176	239	8,3	4,5	2,1	172	176	258	2	0,37	1,8	2,7	1,8	25
22232.CC.W33	22232.CC.K.W33		290	80	1.033	1.278	117	1.900	2.660		191	250	13,9	7,5	3	174	—	276	2,5	0,26	2,6	3,9	2,5	22,5
22232.2CS5.VT143	22232.2CS5K.VT143		290	80	1.034	1.278	117	—	570		185	264	13,9	7,5	3	174	185	276	2,5	0,25	2,7	4	2,5	22,5
23232.CC.W33	23232.CC.K.W33		290	104	1.269	1.644	152	1.425	2.090		188	244	13,9	7,5	3	174	—	276	2,5	0,35	1,9	2,9	1,8	31
22332.CC.W33	22332.CC.K.W33		340	114	1.664	1.941	159	1.425	1.805		200	282	16,7	9	4	177	—	323	3	0,35	1,9	2,9	1,8	52
22332.2CS5.VT143	22332.2CS5K.VT143		340	114	1.667	1.941	159	—	361		193	296	16,7	9	4	177	193	323	3	0,33	2	3	2	52
23034.CC.W33	23034.CC.K.W33	170	260	67	738	1.050	99	2.090	2.660	170	191	232	11,1	6	2,1	181	—	249	2	0,23	2,9	4,4	2,8	13
23034.2CS5.VT143	23034.2CS5K.VT143		260	67	739	1.070	99	—	599		188	243	11,1	6	2,1	181	188	249	2	0,22	3	4,6	2,8	13
24034.CC.W33	24034.CC.K30.W33		260	90	954	1.446	136	1.520	2.280		188	226	8,3	4,5	2,1	181	—	249	2	0,33	2	3	2	17,5
24034.2CS5.VT143	—		260	90	957	1.485	136	—	380		184	235	8,3	4,5	2,1	181	184	249	2	0,3	2,3	3,4	2,2	17,5
23134.CC.W33	23134.CC.K.W33		280	88	1.076	1.485	136	1.710	2.280		195	244	13,9	7,5	2,1	182	—	268	2	0,3	2,3	3,4	2,2	22
23134.2CS5.VT143	23134.2CS5K.VT143		280	88	1.078	1.485	136	—	456		190	256	13,9	7,5	2,1	182	190	268	2	0,28	2,4	3,6	2,5	22
24134.CC.W33	24134.CC.K30.W33		280	109	1.258	1.842	169	1.140	1.710		190	237	8,3	4,5	2,1	182	—	268	2	0,37	1,8	2,7	1,8	27,5
24134.2CS5.VT143	—		280	109	1.261	1.842	169	—	342		185	248	8,3	4,5	2,1	182	185	268	2	0,35	1,9	2,9	1,8	27,5
22234.CC.W33	22234.CC.K.W33		310	86	1.172	1.446	131	1.805	2.470		203	267	16,7	9	4	187	—	293	3	0,27	2,5	3,7	2,5	28,5
22234.2CS5.VT143	22234.2CS5K.VT143		310	86	1.174	1.446	133	—	475		198	282	16,7	9	4	187	198	293	3	0,25	2,7	4	2,5	28,5
23234.CC.W33	23234.CC.K.W33		310	110	1.458	1.911	172	1.330	1.900		200	261	13,9	7,5	4	187	—	293	3	0,35	1,9	2,9	1,8	37,5
22334.CC.W33	22334.CC.K.W33		360	120	1.845	2.139	175	1.330	1.710		213	300	16,7	9	4	187	—	343	3	0,33	2	3	2	61

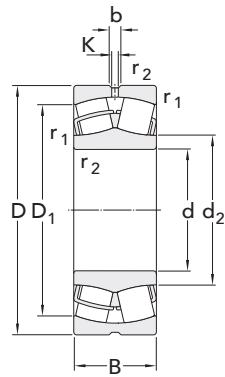

Cylindrical bore

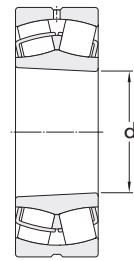

Tapered bore

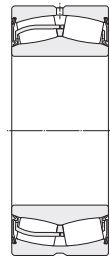

Sealed

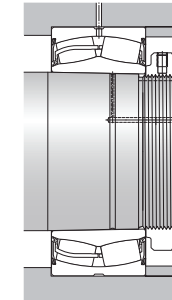
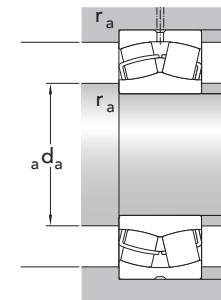

Dimension table

Designation	Main dimensions	Basic load ratings		Fatigue load limit	Speed ratings		Dimensions					Mounting dimensions				Calculation factors				Mass				
		d	D		B	C	C ₀	P _u	Reference speed	Limiting speed	d	d ₂₌	D ₁₌	b	K	r _{1,2} min	d _a min	d _a max	D _a max		r _a max	e	Y ₁	Y ₂
Bearing with cylindrical bore	Bearing with tapered bore	mm			kN		kN	r/min		mm						mm								kg
23936.CC.W33	23936.CC.K.W33	180	250	52	514	822	76	2.470	2.660	180	199	231	6	3	2	189	—	241	2	0,18	3,8	5,6	3,6	7,9
23036.CC.W33	23036.CC.K.W33		280	74	875	1.238	113	1.900	2.470		204	249	13,9	7,5	2,1	191	—	269	2	0,24	2,8	4,2	2,8	17
23036.2CS5.VT143	23036.2CS5K.VT143		280	74	876	1.258	113	—	532		199	262	13,9	7,5	2,1	191	199	269	2	0,22	3	4,6	2,8	17
24036.CC.W33	24036.CC.K30.W33		280	100	1.123	1.713	155	1.425	2.090		201	243	8,3	4,5	2,1	191	—	269	2	0,33	2	3	2	23
24036.2CS5.VT143	—		280	100	1.125	1.713	155	—	361		194	251	8,3	4,5	2,1	191	194	269	2	0,31	2,2	3,3	2,2	23
23136.CC.W33	23136.CC.K.W33		300	96	1.251	1.743	159	1.615	2.090		207	259	13,9	7,5	3	194	—	286	2,5	0,3	2,3	3,4	2,2	28
23136.2CS5.VT143	23136.2CS5K.VT143		300	96	1.252	1.782	159	—	409		202	272	13,9	7,5	3	194	202	286	2,5	0,28	2,4	3,6	2,5	28
24136.CC.W33	24136.CC.K30.W33		300	118	1.435	2.139	195	1.045	1.520		203	253	11,1	6	3	194	—	286	2,5	0,37	1,8	2,7	1,8	34,5
24136.2CS5.VT143	—		300	118	1.438	2.139	195	—	342		198	266	11,1	6	3	194	198	286	2,5	0,37	1,8	2,7	1,8	34,5
22236.CC.W33	22236.CC.K.W33		320	86	1.225	1.545	139	1.710	2.470		213	278	16,7	9	4	197	—	303	3	0,26	2,6	3,9	2,5	29,5
22236.2CS5.VT143	22236.2CS5K.VT143		320	86	1.227	1.545	139	—	504		208	289	16,7	9	4	197	208	303	3	0,24	2,8	4,2	2,8	29
23236.CC.W33	23236.CC.K.W33		320	112	1.542	2.099	185	1.235	1.805		211	271	13,9	7,5	4	197	—	303	3	0,35	1,9	2,9	1,8	39,5
22336.CC.W33	22336.CC.K.W33		380	126	2.057	2.426	192	1.235	1.615		224	317	22,3	12	4	197	—	363	3	0,35	1,9	2,9	1,8	71,5
23938.CC.W33	23938.CC.K.W33	190	260	52	495	792	76	2.280	2.470	190	209	240	6	3	2	199	—	251	2	0,16	4,2	6,3	4	8,3
23038.CC.W33	23038.CC.K.W33		290	75	907	1.327	121	1.805	2.280		216	261	13,9	7,5	2,1	201	—	279	2	0,23	2,9	4,4	2,8	18
24038.CC.W33	24038.CC.K30.W33		290	100	1.153	1.782	162	1.330	1.900		210	253	8,3	4,5	2,1	201	—	279	2	0,31	2,2	3,3	2,2	24,5
23138.CC.W33	23138.CC.K.W33		320	104	1.442	2.060	182	1.425	1.900		220	275	13,9	7,5	3	204	—	306	2,5	0,31	2,2	3,3	2,2	35
23138.2CS5.VT143	23138.2CS5K.VT143		320	104	1.444	2.060	182	—	380		215	288	13,9	7,5	3	204	215	306	2,5	0,3	2,3	3,4	2,2	35
24138.CC.W33	24138.CC.K30.W33		320	128	1.636	2.475	210	1.045	1.425		215	268	11,1	6	3	204	—	306	2,5	0,4	1,7	2,5	1,6	43
24138.2CS5.VT143	—		320	128	1.639	2.475	210	—	323		210	282	11,1	6	3	204	210	306	2,5	0,37	1,8	2,7	1,8	43
22238.CC.W33	22238.CC.K.W33		340	92	1.329	1.683	149	1.615	2.280		225	294	16,7	9	4	207	—	323	3	0,26	2,6	3,9	2,5	36,5
22238.2CS5.VT143	22238.2CS5K.VT143		340	92	1.332	1.683	149	—	456		220	306	16,7	9	4	207	220	323	3	0,24	2,8	4,2	2,8	35
23238.CC.W33	23238.CC.K.W33		340	120	1.742	2.376	206	1.235	1.710		222	287	16,7	9	4	207	—	323	3	0,35	1,9	2,9	1,8	48
22338.CC.W33	22338.CC.K.W33		400	132	2.210	2.624	206	1.140	1.520		236	333	22,3	12	5	210	—	380	4	0,35	1,9	2,9	1,8	82,5
22338.2CS5.VT143	—		400	132	2.214	2.624	206	—	323		228	352	22,3	12	5	210	228	380	4	0,33	2	3	2	77,5

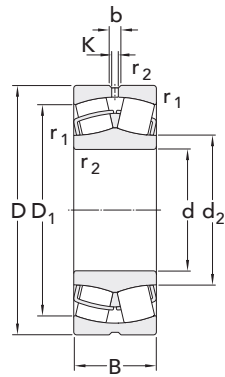

Cylindrical bore

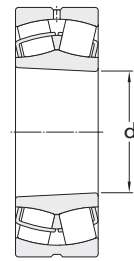

Tapered bore



Sealed

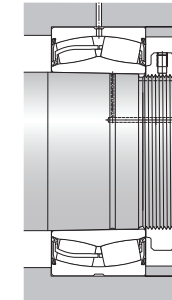
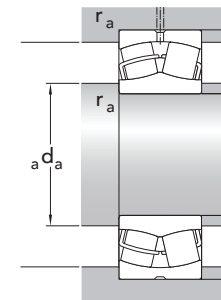

Dimension table

Designation	Main dimensions	Basic load ratings		Fatigue load limit	Speed ratings		Dimensions					Mounting dimensions				Calculation factors			Mass					
		d	D		B	C	C ₀	P _u	Reference speed	Limiting speed	d	d ₂₌	D ₁₌	b	K	r _{1,2} min	d _a min	d _a max		D _a max	r _a max	e	Y ₁	Y ₂
Bearing with cylindrical bore	Bearing with tapered bore	mm			kN		kN	r/min		mm						mm								kg
23940.CC.W33	23940.CC.K.W33	200	280	60	645	1.030	93	2.090	2.280	200	222	258	8,3	4,5	2,1	211	–	269	2	0,19	3,6	5,3	3,6	11,5
23040.CC.W33	23040.CC.K.W33		310	82	1.048	1.515	136	1.710	2.090		228	278	13,9	7,5	2,1	211	–	299	2	0,24	2,8	4,2	2,8	23,5
23040.2CS5.VT143	23040.2CS5K.VT143		310	82	1.049	1.515	136	–	456		223	286	13,9	7,5	2,1	211	223	299	2	0,22	3	4,6	2,8	22
24040.CC.W33	24040.CC.K30.W33		310	109	1.340	2.099	185	1.235	1.805		223	268	11,1	6	2,1	211	–	299	2	0,33	2	3	2	31
23140.CC.W33	23140.CC.K.W33		340	112	1.649	2.337	202	1.425	1.805		231	293	16,7	9	3	214	–	326	2,5	0,31	2,2	3,3	2,2	43
23140.2CS5.VT143	23140.2CS5K.VT143		340	112	1.652	2.337	202	–	361		227	306	16,7	9	3	214	227	326	2,5	0,3	2,3	3,4	2,2	43
24140.CC.W33	24140.CC.K30.W33		340	140	1.847	2.772	230	950	1.330		226	284	11,1	6	3	214	–	326	2,5	0,4	1,7	2,5	1,6	53,5
24140.2CS5.VT143	–		340	140	1.853	2.772	230	–	304		221	294	11,1	6	3	214	221	326	2,5	0,37	1,8	2,7	1,8	53,5
22240.CC.W33	22240.CC.K.W33		360	98	1.511	1.911	165	1.520	2.090		238	313	16,7	9	4	217	–	343	3	0,26	2,6	3,9	2,5	43,5
22240.2CS5.VT143	22240.2CS5K.VT143		360	98	1.514	1.911	165	–	409		232	324	16,7	9	4	217	232	343	3	0,24	2,8	4,2	2,8	42
23240.CC.W33	23240.CC.K.W33		360	128	1.928	2.673	226	1.140	1.615		235	304	16,7	9	4	217	–	343	3	0,35	1,9	2,9	1,8	58
23240.2CS5.VT143	23240.2CS5K.VT143		360	128	1.931	2.673	230	–	323		230	320	16,7	9	4	217	230	343	3	0,33	2	3	2	58
22340.CC.W33	22340.CC.K.W33		420	138	2.415	2.871	222	1.140	1.425		249	351	22,3	12	5	220	–	400	4	0,33	2	3	2	95
23944.CC.W33	23944.CC.K.W33	220	300	60	655	1.070	93	1.900	2.090	220	241	278	8,3	4,5	2,1	231	–	289	2	0,16	4,2	6,3	4	12,5
23944.2CS.VT143	–		300	60	656	1.070	93	–	570		238	284	8,3	4,5	2,1	231	238	289	2	0,15	4,5	6,7	4,5	12,5
23044.CC.W33	23044.CC.K.W33		340	90	1.249	1.842	162	1.520	1.900		250	306	13,9	7,5	3	233	–	327	2,5	0,24	2,8	4,2	2,8	30,5
23044.2CS5.VT143	23044.2CS5K.VT143		340	90	1.250	1.842	162	–	409		245	314	13,9	7,5	3	233	245	327	2,5	0,22	3	4,6	2,8	29
24044.CC.W33	24044.CC.K30.W33		340	118	1.612	2.574	210	1.140	1.615		244	295	11,1	6	3	233	–	327	2,5	0,33	2	3	2	40
23144.CC.W33	23144.CC.K.W33		370	120	1.870	2.723	230	1.235	1.615		255	320	16,7	9	4	237	–	353	3	0,3	2,3	3,4	2,2	53,5
23144.2CS5.VT143	23144.2CS5K.VT143		370	120	1.873	2.723	230	–	342		249	332	16,7	9	4	237	249	353	3	0,28	2,4	3,6	2,5	53,5
24144.CC.W33	24144.CC.K30.W33		370	150	2.176	3.317	283	808	1.140		248	310	11,1	6	4	237	–	353	3	0,4	1,7	2,5	1,6	67
22244.CC.W33	22244.CC.K.W33		400	108	1.817	2.337	195	1.425	1.900		263	346	16,7	9	4	237	–	383	3	0,27	2,5	3,7	2,5	60,5
22244.2CS5.VT143	22244.2CS5K.VT143		400	108	1.821	2.337	198	–	361		257	359	16,7	9	4	237	257	383	3	0,25	2,7	4	2,5	58
23244.CC.W33	23244.CC.K.W33		400	144	2.461	3.416	283	1.045	1.425		259	338	16,7	9	4	237	–	383	3	0,35	1,9	2,9	1,8	81,5
22344.CC.W33	22344.CC.K.W33		460	145	2.811	3.416	258	950	1.330		279	389	22,3	12	5	240	–	440	4	0,31	2,2	3,3	2,2	120
22344.2CS5.VT143	22344.2CS5K.VT143		460	145	2.816	3.416	258	–	285		270	406	22,3	12	5	240	270	440	4	0,3	2,3	3,4	2,2	115

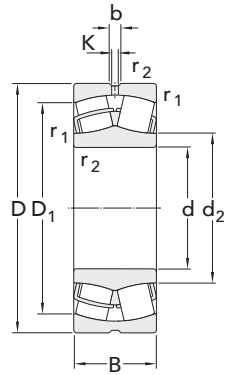

Cylindrical bore

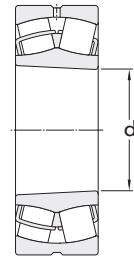

Tapered bore



Sealed

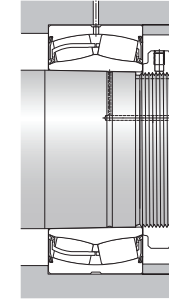
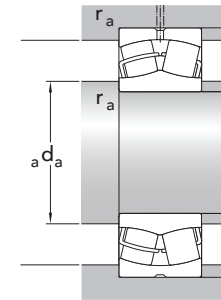

Dimension table

Designation	Main dimensions	Basic load ratings		Fatigue load limit	Speed ratings		Dimensions						Mounting dimensions				Calculation factors				Mass				
		d	D		B	C	C ₀	P _u	Reference speed	Limiting speed	d	d ₂	D ₁	b	K	r _{1,2} min	d _a min	d _a max	D _a max	r _a max		e	Y ₁	Y ₂	Y ₀
Bearing with cylindrical bore	Bearing with tapered bore	mm			kN		kN	r/min								mm									kg
23948.CC.W33	23948.CC.K.W33	240	320	60	679	1.149	98	1.805	1.900	240	261	298	8,3	4,5	2,1	251	—	309	2	0,15	4,5	6,7	4,5	13,5	
23048.CC.W33	23048.CC.K.W33	360	92	1.327	2.060	175	175	1.425	1.805	271	326	333	13,9	7,5	3	253	—	347	2,5	0,23	2,9	4,4	2,8	33,5	
23048.2CS5.VT143	23048.2CS5K.VT143	360	92	1.328	2.060	175	175	—	380	265	333	333	13,9	7,5	3	253	265	347	2,5	0,21	3,2	4,8	3,2	32	
24048.CC.W33	24048.CC.K30.W33	360	118	1.647	2.673	226	226	1.045	1.520	265	316	316	11,1	6	3	253	—	347	2,5	0,3	2,3	3,4	2,2	43	
23148.CC.W33	23148.CC.K.W33	400	128	2.166	3.168	253	253	1.140	1.520	277	348	348	16,7	9	4	257	—	383	3	0,3	2,3	3,4	2,2	66,5	
23148.2CS5.VT143	23148.2CS5K.VT143	400	128	2.170	3.168	253	253	—	323	270	360	360	16,7	9	4	257	270	383	3	0,28	2,4	3,6	2,5	66,5	
24148.CC.W33	24148.CC.K30.W33	400	160	2.465	3.861	317	317	713	1.045	271	336	336	11,1	6	4	257	—	383	3	0,4	1,7	2,5	1,6	83	
22248.CC.W33	22248.CC.K.W33	440	120	2.236	2.970	243	243	1.235	1.710	290	383	383	22,3	12	4	257	—	423	3	0,27	2,5	3,7	2,5	83	
23248.CC.W33	23248.CC.K.W33	440	160	3.012	4.257	342	342	903	1.235	286	374	374	22,3	12	4	257	—	423	3	0,35	1,9	2,9	1,8	110	
22348.CC.W33	22348.CC.K.W33	500	155	3.197	3.960	288	288	903	1.235	303	423	423	22,3	12	5	260	—	480	4	0,31	2,2	3,3	2,2	155	
23952.CC.W33	23952.CC.K.W33	260	360	75	1.045	1.782	155	1.615	1.805	287	331	331	8,3	4,5	2,1	271	—	349	2	0,18	3,8	5,6	3,6	23,5	
23052.CC.W33	23052.CC.K.W33	400	104	1.659	2.525	210	210	1.235	1.615	295	360	360	16,7	9	4	275	—	385	3	0,23	2,9	4,4	2,8	48,5	
23052.2CS5.VT143	23052.2CS5K.VT143	400	104	1.661	2.525	210	210	—	342	289	369	369	16,7	9	4	275	289	385	3	0,22	3	4,6	2,8	46	
24052.CC.W33	24052.CC.K30.W33	400	140	2.114	3.416	283	283	950	1.330	289	347	347	11,1	6	4	275	—	385	3	0,33	2	3	2	65,5	
23152.CC.W33	23152.CC.K.W33	440	144	2.638	3.861	288	288	1.045	1.330	301	380	380	16,7	9	4	277	—	423	3	0,31	2,2	3,3	2,2	90,5	
23152.2CS5.VT143	23152.2CS5K.VT143	440	144	2.642	3.861	288	288	—	304	293	398	398	16,7	9	4	277	293	423	3	0,3	2,3	3,4	2,2	90,5	
24152.CC.W33	24152.CC.K30.W33	440	180	3.056	4.752	377	377	637	903	293	368	368	13,9	7,5	4	277	—	423	3	0,4	1,7	2,5	1,6	110	
24152.2CS5.VT143	—	440	180	3.062	4.851	377	377	—	228	286	391	391	13,9	7,5	4	277	286	423	3	0,4	1,7	2,5	1,6	109	
22252.CC.W33	22252.CC.K.W33	480	130	2.695	3.515	283	283	1.140	1.520	312	421	421	22,3	12	5	280	—	460	4	0,27	2,5	3,7	2,5	110	
23252.CC.W33	23252.CC.K.W33	480	174	3.362	4.703	357	357	808	1.140	312	408	408	22,3	12	5	280	—	460	4	0,35	1,9	2,9	1,8	140	
22352.CC.W33	22352.CC.K.W33	540	165	3.644	4.505	322	322	808	1.045	328	458	458	22,3	12	6	286	—	514	5	0,31	2,2	3,3	2,2	190	
23956.CC.W33	23956.CC.K.W33	280	380	75	1.006	1.743	142	1.520	1.615	308	352	352	11,1	6	2,1	291	—	369	2	0,16	4,2	6,3	4	25	
23056.CC.W33	23056.CC.K.W33	420	106	1.780	2.822	222	222	1.235	1.520	315	380	380	16,7	9	4	295	—	405	3	0,23	2,9	4,4	2,8	52,5	
24056.CC.W33	24056.CC.K30.W33	420	140	2.226	3.762	283	283	903	1.330	309	368	368	11,1	6	4	295	—	405	3	0,31	2,2	3,3	2,2	69,5	
23156.CC.W33	23156.CC.K.W33	460	146	2.757	4.208	332	332	950	1.235	321	401	401	16,7	9	5	300	—	440	4	0,3	2,3	3,4	2,2	97	
23156.2CS5.VT143	23156.2CS5K.VT143	460	146	2.761	4.208	332	332	—	285	314	417	417	16,7	9	5	300	314	440	4	0,28	2,4	3,6	2,5	97	
24156.CC.W33	24156.CC.K30.W33	460	180	3.152	5.049	411	411	599	855	314	390	390	13,9	7,5	5	300	—	440	4	0,4	1,7	2,5	1,6	120	
24156.2CS5.VT143	24156.2CS5K30.VT143	460	180	3.159	5.049	411	411	—	209	307	413	413	13,9	7,5	5	300	307	440	4	0,37	1,8	2,7	1,8	115	
22256.CC.W33	22256.CC.K.W33	500	130	2.768	3.713	297	297	1.045	1.425	333	441	441	22,3	12	5	300	—	480	4	0,26	2,6	3,9	2,5	115	
23256.CC.W33	23256.CC.K.W33	500	176	3.391	4.851	362	362	760	1.045	332	429	429	22,3	12	5	300	—	480	4	0,35	1,9	2,9	1,8	150	
22356.CC.W33	22356.CC.K.W33	580	175	4.117	5.148	362	362	760	1.045	354	492	492	22,3	12	6	306	—	554	5	0,3	2,3	3,4	2,2	235	

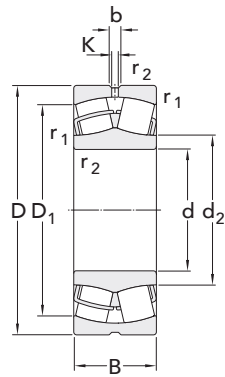

Cylindrical bore

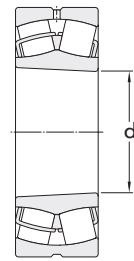

Tapered bore



Sealed

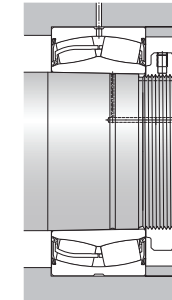
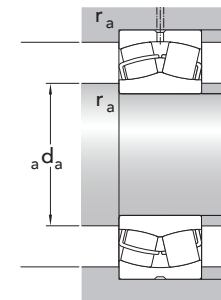

Dimension table

Designation	Main dimensions	Basic load ratings		Fatigue load limit	Speed ratings		Dimensions					Mounting dimensions				Calculation factors				Mass				
		d	D		B	C	C ₀	P _u	Reference speed	Limiting speed	d	d ₂₌	D ₁₌	b	K	r _{1,2} min	d _a min	d _a max	D _a max		r _a max	e	Y ₁	Y ₂
Bearing with cylindrical bore	Bearing with tapered bore	mm			kN		kN	r/min		mm						mm								kg
23960.CC.W33	23960.CC.K.W33	300	420	90	1.399	2.475	198	1.330	1.520	300	333	385	11,1	6	3	313	—	407	2,5	0,19	3,6	5,3	3,6	39,5
23060.CC.W33	23060.CC.K.W33		460	118	2.197	3.416	263	1.140	1.425		340	414	16,7	9	4	315	—	445	3	0,23	2,9	4,4	2,8	71,5
23060.2CS5.VT143	23060.2CS5K.VT143		460	118	2.200	3.416	263	—	304		334	433	16,7	9	4	315	334	445	3	0,22	3	4,6	2,8	71,5
24060.CC.W33	24060.CC.K30.W33		460	160	2.793	4.703	352	808	1.140		331	400	13,9	7,5	4	315	—	445	3	0,33	2	3	2	97
24060.2CS5.VT143	—		460	160	2.799	4.703	352	—	228		325	416	13,9	7,5	4	315	325	445	3	0,31	2,2	3,3	2,2	95
23160.CC.W33	23160.CC.K.W33		500	160	3.335	5.049	377	903	1.140		345	434	16,7	9	5	320	—	480	4	0,3	2,3	3,4	2,2	125
23160.2CS5.VT143	23160.2CS5K.VT143		500	160	3.340	5.049	377	—	247		337	451	16,7	9	5	320	337	480	4	0,28	2,4	3,6	2,5	125
24160.CC.W33	24160.CC.K30.W33		500	200	3.838	6.237	461	532	760		338	422	13,9	7,5	5	320	—	480	4	0,4	1,7	2,5	1,6	160
24160.2CS5.VT143	24160.2CS5K30.VT143		500	200	3.843	6.237	461	—	202		330	447	13,9	7,5	5	320	330	480	4	0,37	1,8	2,7	1,8	156
22260.CC.W33	22260.CC.K.W33		540	140	3.207	4.208	322	950	1.330		354	477	22,3	12	5	311	—	520	4	0,26	2,6	3,9	2,5	135
23260.CC.W33	23260.CC.K.W33		540	192	4.012	5.792	421	713	950		356	461	22,3	12	5	320	—	520	4	0,35	1,9	2,9	1,8	190
23964.CC.W33	23964.CC.K.W33	320	440	90	1.466	2.673	210	1.330	1.425	320	354	406	11,1	6	3	333	—	427	2,5	0,17	4	5,9	4	42
23064.2CS5.VT143	23064.2CS5K.VT143		480	121	2.325	3.762	283	—	304		354	448	16,7	9	4	335	354	465	3	0,23	2,9	4,4	2,8	75,5
23064.CC.W33	23064.CC.K.W33		480	121	2.325	3.762	283	1.045	1.330		360	434	16,7	9	4	335	—	465	3	0,23	2,9	4,4	2,8	78
24064.CC.W33	24064.CC.K30.W33		480	160	2.940	5.049	396	760	1.140		354	423	13,9	7,5	4	335	—	465	3	0,31	2,2	3,3	2,2	100
23164.CC.W33	23164.CC.K.W33		540	176	3.884	5.940	436	808	1.045		370	465	22,3	12	5	340	—	520	4	0,31	2,2	3,3	2,2	165
23164.2CS5.VT143	23164.2CS5K.VT143		540	176	3.890	6.039	436	—	247		361	483	22,3	12	5	340	361	520	4	0,3	2,3	3,4	2,2	165
24164.CC.W33	24164.CC.K30.W33		540	218	4.352	7.029	505	475	665		364	455	16,7	9	5	340	—	520	4	0,4	1,7	2,5	1,6	210
22264.CC.W33	22264.CC.K.W33		580	150	3.671	4.851	372	903	1.235		379	513	22,3	12	5	340	—	560	4	0,26	2,6	3,9	2,5	175
23264.CC.W33	23264.CC.K.W33		580	208	4.561	6.633	471	665	903		382	493	22,3	12	5	340	—	560	4	0,35	1,9	2,9	1,8	240
23968.CC.W33	23968.CC.K.W33	340	460	90	1.476	2.772	214	1.235	1.330	340	373	426	11,1	6	3	353	—	447	2,5	0,17	4	5,9	4	45,5
23068.CC.W33	23068.CC.K.W33		520	133	2.784	4.505	332	950	1.235		385	468	22,3	12	5	358	—	502	4	0,24	2,8	4,2	2,8	105
24068.CC.W33	24068.CC.K30.W33		520	180	3.585	6.138	471	713	1.045		377	453	16,7	9	5	358	—	502	4	0,33	2	3	2	140
23168.CC.W33	23168.CC.K.W33		580	190	4.401	6.732	476	760	950		394	498	22,3	12	5	360	—	560	4	0,31	2,2	3,3	2,2	210
23168.2CS5.VT143	23168.2CS5K.VT143		580	190	4.408	6.732	486	—	228		385	515	22,3	12	5	360	385	560	4	0,3	2,3	3,4	2,2	210
24168.ECC.W33	24168.ECC.K30.W33		580	243	5.433	8.564	624	409	599		383	491	16,7	9	5	360	—	560	4	0,4	1,7	2,5	1,6	280
23268.CA.W33	23268.CA.K.W33		620	224	5.309	7.722	545	532	760		427	528	22,3	12	6	366	—	594	5	0,35	1,9	2,9	1,8	295

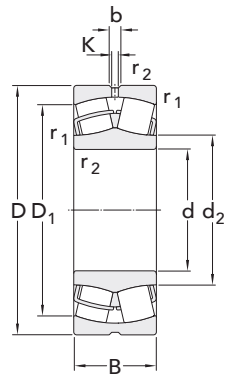

Cylindrical bore

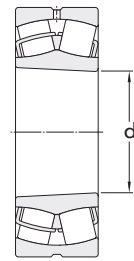

Tapered bore



Sealed

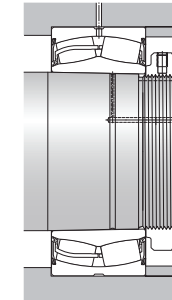
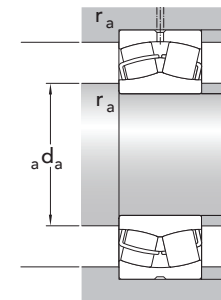

Dimension table

Designation		Main dimensions			Basic load ratings		Fatigue load limit P _u kN	Speed ratings		Dimensions						Mounting dimensions				Calculation factors				Mass kg
Bearing with cylindrical bore	Bearing with tapered bore	d mm	D	B	C	C ₀		Reference speed r/min	Limiting speed	d	d ₂₌	D ₁₌	b	K	r _{1,2} min	d _a min	d _a max	D _a max	r _a max	e	Y ₁	Y ₂	Y ₀	
23972.CC.W33	23972.CC.K.W33	360	480	90	1.442	2.723	218	1.140	1.235	360	394	447	11,1	6	3	373	—	467	2,5	0,15	4,5	6,7	4,5	46
23072.CC.W33	23072.CC.K.W33		540	134	2.822	4.752	342	903	1.140		404	483	22,3	12	5	378	—	522	4	0,23	2,9	4,4	2,8	110
24072.CC.W33	24072.CC.K30.W33		540	180	3.668	6.485	486	665	950		397	474	16,7	9	5	378	—	522	4	0,31	2,2	3,3	2,2	145
23172.CC.W33	23172.CC.K.W33		600	192	4.470	6.881	486	713	950		418	524	22,3	12	5	380	—	580	4	0,3	2,3	3,4	2,2	220
23172.2CS5.VT143	23172.2CS5K.VT143		600	192	4.476	6.881	486	—	209		408	541	22,3	12	5	380	408	580	4	0,28	2,4	3,6	2,5	214
24172.ECC.W33	24172.ECC.K30.W33		600	243	5.680	9.207	664	380	570		404	511	16,7	9	5	380	—	580	4	0,4	1,7	2,5	1,6	280
22272.CA.W33	22272.CA.K.W33		650	170	4.386	6.138	436	599	808		454	568	22,3	12	6	386	—	624	5	0,26	2,6	3,9	2,5	255
23272.CA.W33	23272.CA.K.W33		650	232	5.607	8.217	565	504	713		449	552	22,3	12	6	386	—	624	5	0,35	1,9	2,9	1,8	335
23272.2CS5.VT143	23272.2CS5K.VT143		650	232	5.613	8.217	565	—	152		429	581	22,3	12	6	386	429	624	5	0,35	1,9	2,9	1,8	332
23976.CC.W33	23976.CC.K.W33	380	520	106	1.991	3.762	283	1.045	1.140	380	419	481	13,9	7,5	4	395	—	505	3	0,17	4	5,9	4	69
23076.CC.W33	23076.CC.K.W33		560	135	2.955	4.950	357	855	1.140		426	509	22,3	12	5	398	—	542	4	0,22	3	4,6	2,8	115
24076.CC.W33	24076.CC.K30.W33		560	180	3.749	6.732	471	637	903		419	497	16,7	9	5	398	—	542	4	0,3	2,3	3,4	2,2	150
23176.2CS5.VT143	23176.2CS5K.VT143		620	194	4.516	7.029	495	—	152		438	573	22,3	12	5	400	438	600	4	0,3	2,3	3,4	2,2	232
23176.CA.W33	23176.CA.K.W33		620	194	4.516	7.029	495	532	950		454	541	22,3	12	5	400	—	600	4	0,3	2,3	3,4	2,2	230
24176.ECA.W33	24176.ECA.K30.W33		620	243	5.877	9.702	703	342	504		444	532	16,7	9	5	400	—	600	4	0,37	1,8	2,7	1,8	300
23276.CA.W33	23276.CA.K.W33		680	240	6.065	9.059	614	475	713		473	581	22,3	12	6	406	—	654	5	0,35	1,9	2,9	1,8	375
23980.CC.W33	23980.CC.K.W33	400	540	106	2.018	3.861	288	1.045	1.140	400	439	500	13,9	7,5	4	415	—	525	3	0,16	4,2	6,3	4	71
23080.CC.W33	23080.CC.K.W33		600	148	3.476	5.792	411	808	1.045		450	543	22,3	12	5	418	—	582	4	0,23	2,9	4,4	2,8	150
23080.2CS5.VT143	23080.2CS5K.VT143		600	148	3.480	5.792	411	—	228		443	557	22,3	12	5	418	443	582	4	0,21	3,2	4,8	3,2	144
24080.ECC.W33	24080.ECC.K30.W33		600	200	4.462	7.920	555	599	855		442	527	22,3	12	5	418	—	582	4	0,3	2,3	3,4	2,2	205
23180.2CS5.VT143	23180.2CS5K.VT143		650	200	4.816	7.574	525	—	143		458	587	22,3	12	6	426	458	624	5	0,28	2,4	3,6	2,5	255
23180.CA.W33	23180.CA.K.W33		650	200	4.816	7.574	525	504	903		475	566	22,3	12	6	426	—	624	5	0,28	2,4	3,6	2,5	265
24180.ECA.W33	24180.ECA.K30.W33		650	250	6.268	10.494	728	323	475		467	559	22,3	12	6	426	—	624	5	0,37	1,8	2,7	1,8	340
23280.CA.W33	23280.CA.K.W33		720	256	6.813	10.296	674	456	637		500	615	22,3	12	6	426	—	694	5	0,35	1,9	2,9	1,8	450
22380.CA.W33	22380.CA.K.W33		820	243	7.754	10.296	664	409	713		534	697	22,3	12	7,5	432	—	788	6	0,3	2,3	3,4	2,2	650

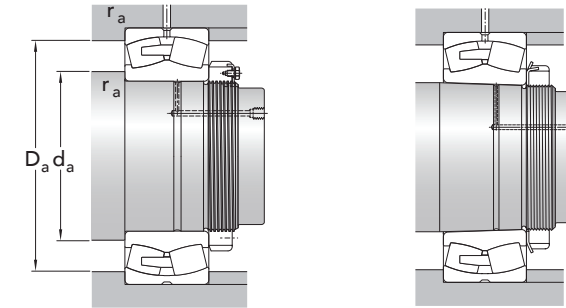
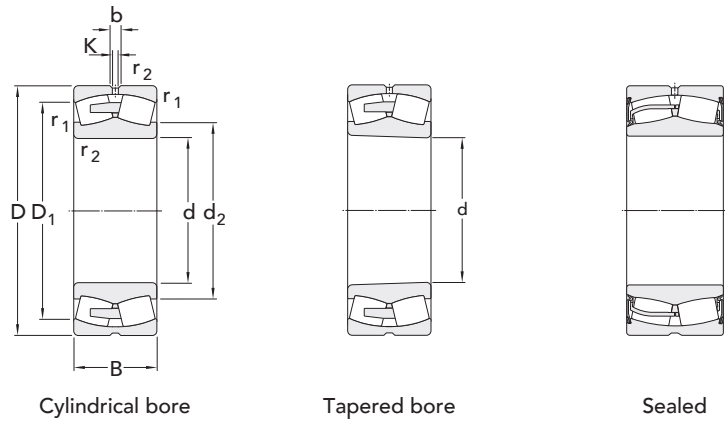

Dimension table

Designation	Main dimensions	Basic load ratings		Fatigue load limit	Speed ratings		Dimensions						Mounting dimensions				Calculation factors			Mass					
		d	D		B	C	C ₀	P _u	Reference speed	Limiting speed	d	d ₂₌	D ₁₌	b	K	r _{1,2} min	d _a min	d _a max	D _a max		r _a max	e	Y ₁	Y ₂	Y ₀
Bearing with cylindrical bore	Bearing with tapered bore	mm			kN		kN	r/min								mm									kg
23984.CC.W33	23984.CC.K.W33	420	560	106	2.075	4.070	290	980	1.080	420	459	520	16,7	9	4	435	—	545	3	0,16	4,2	6,3	4	74,5	
23084.CA.W33	23084.CA.K.W33		620	150	3.470	5.890	400	580	1.060		487	563	22,3	12	5	438	—	602	4	0,22	3	4,6	2,8	155	
24084.ECA.W33	24084.ECA.K30.W33		620	200	4.550	8.220	570	520	880		477	547	22,3	12	5	438	—	602	4	0,3	2,3	3,4	2,2	210	
23184.2CS5.VT143	23184.2CS5K.VT143		700	224	5.780	9.200	612	—	185		490	634	22,3	12	6	446	490	674	5	0,3	2,3	3,4	2,2	350	
23184.CC.W33	23184.CC.K.W33		700	224	5.870	9.180	613	480	890		483	607	22,3	12	6	446	—	674	5	0,3	2,3	3,4	2,2	350	
24184.ECA.W33	24184.ECA.K30.W33		700	280	7.476	12.210	839	317	470		494	597	22,3	12	6	446	—	674	5	0,4	1,7	2,5	1,6	445	
23284.CA.W33	23284.CA.K.W33		760	272	7.500	11.200	753	440	610		526	649	22,3	12	7,5	452	—	728	6	0,35	1,9	2,9	1,8	535	
23284.2CS5.VT143	23284.2CS5K.VT143		760	272	7.500	11.200	753	—	125		500	676	22,3	12	7,5	452	500	728	6	0,35	1,9	2,9	1,8	535	
23988.CC.W33	23988.CC.K.W33	440	600	118	2.498	4.810	341	940	980	440	484	553	16,7	9	4	455	—	585	3	0,16	4,2	6,3	4	99,5	
23088.CA.W33	23088.CA.K.W33		650	157	3.800	6.500	445	550	980		511	590	22,3	12	6	463	—	627	5	0,22	3	4,6	2,8	180	
23088.2CS5.VT143	—		650	157	3.800	6.500	445	—	180		505	614	22,3	12	6	463	505	627	5	0,21	3,2	4,8	3,2	178	
24088.ECA.W33	24088.ECA.K30.W33		650	212	4.900	9.000	615	490	830		499	572	22,3	12	6	463	—	627	5	0,3	2,3	3,4	2,2	245	
23188.CA.W33	23188.CA.K.W33		720	226	6.200	10.000	670	450	840		529	632	22,3	12	6	466	—	694	5	0,3	2,3	3,4	2,2	360	
23188.2CS5.VT143	23188.2CS5K.VT143		720	226	6.200	10.000	670	—	180		513	664	22,3	12	6	466	513	694	5	0,28	2,4	3,6	2,5	360	
24188.ECA.W33	24188.ECA.K30.W33		720	280	7.660	13.000	850	300	450		516	618	22,3	12	6	466	—	694	5	0,37	1,8	2,7	1,8	460	
23288.CA.W33	23288.CA.K.W33		790	280	8.090	12.420	775	415	570		549	676	22,3	12	7,5	472	—	758	6	0,35	1,9	2,9	1,8	590	
24892.CAMA.W20	24892.CA.K30MA.W20	460	580	118	2.000	4.780	340	627	1.090	460	505	541	—	7,5	3	473	—	567	2,5	0,17	4	5,9	4	75,5	
23992.CA.W33	23992.CA.K.W33		620	118	2.500	4.940	345	580	978		516	574	16,7	9	4	475	—	605	3	0,16	4,2	6,3	4	105	
23092.CA.W33	23092.CA.K.W33		680	163	3.990	6.745	450	545	830		533	617	22,3	12	6	483	—	657	5	0,22	3	4,6	2,8	205	
24092.ECA.W33	24092.ECA.K30.W33		680	218	5.400	10.000	670	480	800		524	601	22,3	12	6	483	—	657	5	0,28	2,4	3,6	2,5	275	
23192.CA.W33	23192.CA.K.W33		760	240	6.760	10.800	680	430	800		555	666	22,3	12	7,5	492	—	728	6	0,3	2,3	3,4	2,2	440	
23192.2CS5.VT143	23192.2CS5K.VT143		760	240	6.760	10.800	680	—	130		536	704	22,3	12	7,5	492	536	728	6	0,3	2,3	3,4	2,2	427	
24192.ECA.W33	24192.ECA.K30.W33		760	300	8.730	14.440	985	270	415		543	649	22,3	12	7,5	492	—	728	6	0,37	1,8	2,7	1,8	560	
23292.CA.W33	23292.CA.K.W33		830	296	8.900	13.500	865	390	570		574	706	22,3	12	7,5	492	—	798	6	0,35	1,9	2,9	1,8	695	
23996.CA.W33	23996.CA.K.W33	480	650	128	2.950	5.640	400	555	990	480	537	602	16,7	9	5	498	—	632	4	0,18	3,8	5,6	3,6	125	
23096.CA.W33	23096.CA.K.W33		700	165	4.000	6.820	440	515	900		549	633	22,3	12	6	503	—	677	5	0,21	3,2	4,8	3,2	215	
24096.ECA.W33	24096.ECA.K30.W33		700	218	5.500	10.200	680	438	740		542	619	22,3	12	6	503	—	677	5	0,28	2,4	3,6	2,5	285	
23196.CA.W33	23196.CA.K.W33		790	248	7.400	12.150	783	395	740		579	692	22,3	12	7,5	512	—	758	6	0,3	2,3	3,4	2,2	485	
23196.2CS5.VT143	23196.2CS5K.VT143		790	248	1.400	12.150	783	—	170		560	723	22,3	12	7,5	512	560	758	6	0,3	2,3	3,4	2,2	485	
24196.ECA.W33	24196.ECA.K30.W33		790	308	9.150	15.000	1.000	240	380		564	678	22,3	12	7,5	512	—	758	6	0,37	1,8	2,7	1,8	605	
23296.CA.W33	23296.CA.K.W33		870	310	9.760	14.780	940	370	525		602	741	22,3	12	7,5	512	—	838	6	0,35	1,9	2,9	1,8	800	

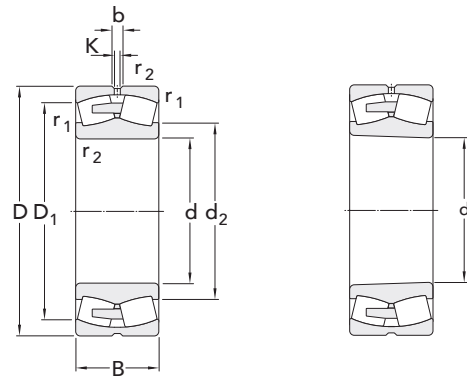

Cylindrical bore

Tapered bore

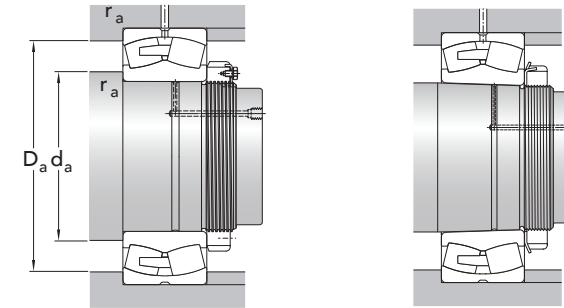

Designation		Main dimensions			Basic load ratings		Fatigue load limit Pu kN	Speed ratings		Dimensions					Mounting dimensions				Calculation factors				Mass kg	
Bearing with cylindrical bore	Bearing with tapered bore	d mm	D	B	C	C0		Reference speed r/min	Limiting speed	d	d2 =	D1 =	b	K	r1,2 min	da min mm	da max	Da max	ra max	e	Y1	Y2		Y0
239-500.CA.W33	239-500.CA.K.W33	500	670	128	2.938	5.940	411	504	903	500	561	622	22,3	12	5	518	-	652	4	0,17	4	5,9	4	130
230-500.CA.W33	230-500.CA.K.W33		720	167	4.315	7.722	505	475	855		573	658	22,3	12	6	523	-	697	5	0,21	3,2	4,8	3,2	225
240-500.ECA.W33	240-500.ECA.K30.W33		720	218	5.720	10.890	728	409	665		566	644	22,3	12	6	523	-	697	5	0,26	2,6	3,9	2,5	295
231-500.CA.W33	231-500.CA.K.W33		830	264	7.957	12.771	822	361	665		605	726	22,3	12	7,5	532	-	798	6	0,3	2,3	3,4	2,2	580
241-500.ECA.W33	241-500.ECA.K30.W33		830	325	10.022	16.830	1.109	247	361		588	713	22,3	12	7,5	532	-	798	6	0,37	1,8	2,7	1,8	700
232-500.CA.W33	232-500.CA.K.W33		920	336	11.072	17.127	1.050	342	475		633	779	22,3	12	7,5	532	-	888	6	0,35	1,9	2,9	1,8	985
248-530.CAMA.W20	248-530.CA.K30MA.W20	530	650	118	2.103	5.247	377	504	903	530	573	612	-	7,5	3	543	-	637	2,5	0,15	4,5	6,7	4,5	86
239-530.CA.W33	239-530.CA.K.W33		710	136	3.275	6.633	461	475	855		594	661	22,3	12	5	548	-	692	4	0,17	4	5,9	4	155
230-530.CA.W33	230-530.CA.K.W33		780	185	5.215	9.207	604	428	760		613	710	22,3	12	6	553	-	757	5	0,22	3	4,6	2,8	310
240-530.ECA.W33	240-530.ECA.K30.W33		780	250	6.904	13.068	822	380	637		601	687	22,3	12	6	553	-	757	5	0,28	2,4	3,6	2,5	410
231-530.CA.W33	231-530.CA.K.W33		870	272	8.441	13.860	872	342	637		638	763	22,3	12	7,5	562	-	838	6	0,3	2,3	3,4	2,2	645
241-530.ECA.W33	241-530.ECA.K30.W33		870	335	10.800	18.810	1.208	228	342		623	748	22,3	12	7,5	562	-	838	6	0,37	1,8	2,7	1,8	830
232-530.CA.W33	232-530.CA.K.W33		980	355	13.136	20.196	1.208	304	456		670	836	22,3	12	9,5	570	-	940	8	0,35	1,9	2,9	1,8	1.200
239-560.CA.W33	239-560.CA.K.W33	560	750	140	3.536	7.128	495	428	808	560	627	697	22,3	12	5	578	-	732	4	0,16	4,2	6,3	4	175
230-560.CA.W33	230-560.CA.K.W33		820	195	5.722	10.098	664	409	713		646	746	22,3	12	6	583	-	797	5	0,22	3	4,6	2,8	355
240-560.ECA.W33	240-560.ECA.K30.W33		820	258	7.545	14.454	971	361	599		637	728	22,3	12	6	583	-	797	5	0,28	2,4	3,6	2,5	465
231-560.CA.W33	231-560.CA.K.W33		920	280	9.501	15.840	971	323	599		675	809	22,3	12	7,5	592	-	888	6	0,3	2,3	3,4	2,2	740
241-560.ECC.W33	241-560.ECC.K30.W33		920	355	12.243	21.384	1.327	209	304		634	796	22,3	12	7,5	592	-	888	6	0,35	1,9	2,9	1,8	985
232-560.CA.W33	232-560.CA.K.W33		1.030	365	13.801	21.780	1.307	266	409		706	878	22,3	12	9,5	600	-	990	8	0,35	1,9	2,9	1,8	1.350
239-600.CA.W33	239-600.CA.K.W33	600	800	150	3.982	8.217	565	409	713	600	671	744	22,3	12	5	618	-	782	4	0,17	4	5,9	4	220
230-600.CA.W33	230-600.CA.K.W33		870	200	6.190	11.286	728	380	665		685	789	22,3	12	6	623	-	847	5	0,22	3	4,6	2,8	405
240-600.ECA.W33	240-600.ECA.K30.W33		870	272	8.495	16.830	1.070	323	532		675	774	22,3	12	6	623	-	847	5	0,3	2,3	3,4	2,2	520
231-600.CA.W33	231-600.CA.K.W33		980	300	10.631	17.820	1.089	304	532		722	863	22,3	12	7,5	632	-	948	6	0,3	2,3	3,4	2,2	895
241-600.ECA.W33	241-600.ECA.K30.W33		980	375	13.387	23.364	1.446	190	285		702	845	22,3	12	7,5	632	-	948	6	0,37	1,8	2,7	1,8	1.200
232-600.CA.W33	232-600.CA.K.W33		1.090	388	15.496	25.245	1.446	247	380		754	929	22,3	12	9,5	640	-	1.050	8	0,35	1,9	2,9	1,8	1.600
238-630.CAMA.W20	-	630	780	112	2.520	6.039	411	409	713	630	682	738	-	9	4	645	-	765	3	0,12	5,6	8,4	5,6	120
239-630.CA.W33	239-630.CA.K.W33		850	165	4.697	9.702	624	380	665		708	787	22,3	12	6	653	-	827	5	0,17	4	5,9	4	280
230-630.CA.W33	230-630.CA.K.W33		920	212	6.830	12.375	773	361	637		727	839	22,3	12	7,5	658	-	892	6	0,21	3,2	4,8	3,2	485
240-630.ECC.W33	240-630.ECC.K30.W33		920	290	9.059	17.820	1.109	304	504		697	823	22,3	12	7,5	658	-	892	6	0,28	2,4	3,6	2,5	645
231-630.CA.W33	231-630.CA.K.W33		1.030	315	12.474	20.592	1.208	247	504		755	918	22,3	12	7,5	662	-	998	6	0,3	2,3	3,4	2,2	1.050
241-630.ECA.W33	241-630.ECA.K30.W33		1.030	400	14.851	26.730	1.614	181	266		738	885	22,3	12	7,5	662	-	998	6	0,37	1,8	2,7	1,8	1.400

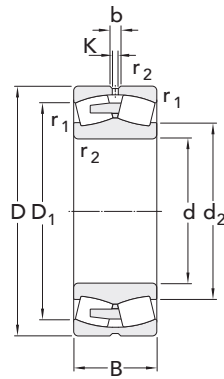

Cylindrical bore

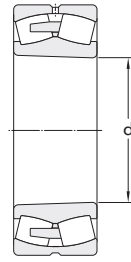

Tapered bore

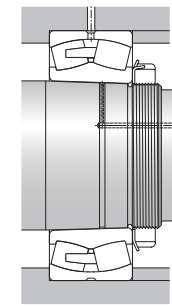
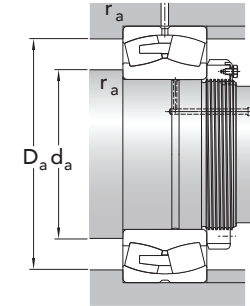

Dimension table

Designation		Main dimensions			Basic load ratings		Fatigue load limit Pu kN	Speed ratings		Dimensions					Mounting dimensions				Calculation factors			Mass kg		
Bearing with cylindrical bore	Bearing with tapered bore	d mm	D	B	C	C0		Reference speed r/min	Limiting speed	d	d2 =	D1 =	b	K	r1,2 min	da min	da max	Da max	ra max	e	Y1		Y2	Y0
238-670.CAMA.W20	—	670	820	112	2.617	6.336	426	380	665	670	724	778	—	9	4	685	—	805	3	0,11	6,1	9,1	6,3	130
248-670.CAMA.W20	—		820	150	3.563	9.405	649	380	665		726	772	—	9	4	685	—	805	3	0,16	4,2	6,3	4	172
239-670.CA.W33	239-670.CA.K.W33		900	170	5.095	10.692	674	342	637		752	835	22,3	12	6	693	—	877	5	0,17	4	5,9	4	315
230-670.CA.W33	230-670.CA.K.W33		980	230	7.840	14.454	872	323	570		772	892	22,3	12	7,5	698	—	952	6	0,21	3,2	4,8	3,2	600
240-670.ECA.W33	240-670.ECA.K30.W33		980	308	10.331	20.196	1.278	285	475		758	866	22,3	12	7,5	698	—	952	6	0,28	2,4	3,6	2,5	790
231-670.CA.W33	231-670.CA.K.W33		1.090	336	12.970	22.176	1.307	228	475		804	959	22,3	12	7,5	702	—	1.058	6	0,3	2,3	3,4	2,2	1.250
241-670.ECA.W33	241-670.ECA.K30.W33		1.090	412	16.218	28.710	1.743	171	247		782	942	22,3	12	7,5	702	—	1.058	6	0,37	1,8	2,7	1,8	1.600
232-670.CA.W33	232-670.CA.K.W33		1.220	438	18.464	30.195	1.683	209	342		832	1.028	22,3	12	12	718	—	1.172	10	0,35	1,9	2,9	1,8	2.270
238-710.CAMA.W20	—	710	870	118	2.983	7.425	495	342	637	710	766	826	—	12	4	725	—	855	3	0,11	6,1	9,1	6,3	153
239-710.CA.W33	239-710.CA.K.W33		950	180	5.645	11.880	743	323	570		794	882	22,3	12	6	733	—	927	5	0,17	4	5,9	4	365
249-710.CA.W33	249-710.CA.K30.W33		950	243	6.792	15.444	921	285	475		792	868	22,3	12	6	733	—	927	5	0,22	3	4,6	2,8	495
230-710.CA.W33	230-710.CA.K.W33		1.030	236	8.583	16.137	956	285	532		816	941	22,3	12	7,5	738	—	1.002	6	0,21	3,2	4,8	3,2	670
240-710.ECA.W33	240-710.ECA.K30.W33		1.030	315	11.053	22.572	1.416	247	428		809	918	22,3	12	7,5	738	—	1.002	6	0,27	2,5	3,7	2,5	895
231-710.CA.W33	231-710.CA.K.W33		1.150	345	14.585	25.740	1.515	228	428		851	1.017	22,3	12	9,5	750	—	1.110	8	0,28	2,4	3,6	2,5	1.450
241-710.ECA.W33	241-710.ECA.K30.W33		1.150	438	17.756	32.175	1.881	152	228		826	989	22,3	12	9,5	750	—	1.110	8	0,37	1,8	2,7	1,8	1.900
232-710.CA.W33	232-710.CA.K.W33		1.280	450	20.996	34.155	1.980	190	304		875	1.097	22,3	12	12	758	—	1.232	10	0,35	1,9	2,9	1,8	2.610
238-750.CAMA.W20	—	750	920	128	3.371	8.415	545	323	570	750	812	873	—	12	5	768	—	902	4	0,11	6,1	9,1	6,3	185
239-750.CA.W33	239-750.CA.K.W33		1.000	185	6.077	13.068	792	304	532		838	930	22,3	12	6	773	—	977	5	0,16	4,2	6,3	4	420
249-750.CA.W33	249-750.CA.K30.W33		1.000	250	7.623	17.820	1.089	266	456		830	916	22,3	12	6	773	—	977	5	0,22	3	4,6	2,8	560
230-750.CA.W33	230-750.CA.K.W33		1.090	250	9.961	18.414	1.089	266	504		859	998	22,3	12	7,5	778	—	1.062	6	0,21	3,2	4,8	3,2	795
240-750.ECA.W33	240-750.ECA.K30.W33		1.090	335	12.113	24.750	1.446	228	409		855	970	22,3	12	7,5	778	—	1.062	6	0,28	2,4	3,6	2,5	1.070
231-750.CA.W33	231-750.CA.K.W33		1.220	365	16.353	28.710	1.683	209	409		900	1.080	22,3	12	9,5	790	—	1.180	8	0,28	2,4	3,6	2,5	1.700
241-750.ECA.W33	241-750.ECA.K30.W33		1.220	475	20.230	37.125	2.139	143	209		875	1.050	22,3	12	9,5	790	—	1.180	8	0,37	1,8	2,7	1,8	2.100

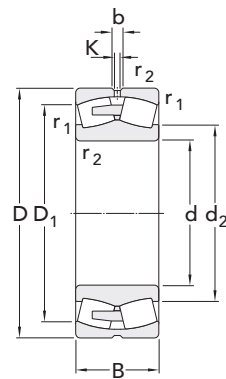

Cylindrical bore

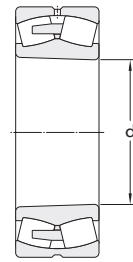

Tapered bore

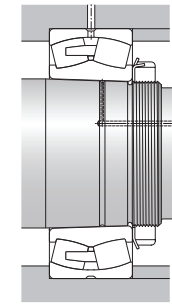
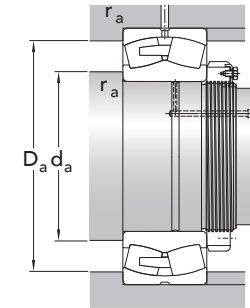

Dimension table

Designation		Main dimensions			Basic load ratings		Fatigue load limit Pu kN	Speed ratings		Dimensions						Mounting dimensions				Calculation factors			Mass kg	
Bearing with cylindrical bore	Bearing with tapered bore	d mm	D	B	C	C0		Reference speed r/min	Limiting speed	d	d2 =	D1 =	b	K	r1,2 min	da min mm	da max	Da max	ra max	e	Y1	Y2		Y0
248-800.CAMA.W20	248-800.CA.K30MA.W20	800	980	180	4.733	12.771	822	304	532	800	865	921	-	12	5	818	-	962	4	0,15	4,5	6,7	4,5	300
239-800.CA.W33	239-800.CA.K.W33		1.060	195	6.530	14.157	857	266	504		891	986	22,3	12	6	823	-	1.037	5	0,16	4,2	6,3	4	470
249-800.CA.W33	249-800.CA.K30.W33		1.060	258	8.055	19.107	1.050	228	409		887	973	22,3	12	6	823	-	1.037	5	0,21	3,2	4,8	3,2	640
230-800.CA.W33	230-800.CA.K.W33		1.150	258	10.232	19.800	1.149	247	456		917	1.053	22,3	12	7,5	828	-	1.122	6	0,2	3,4	5	3,2	895
240-800.ECA.W33	240-800.ECA.K30.W33		1.150	345	13.297	28.215	1.644	209	380		910	1.028	22,3	12	7,5	828	-	1.122	6	0,27	2,5	3,7	2,5	1.200
231-800.CA.W33	231-800.CA.K.W33		1.280	375	17.853	31.185	1.782	190	380		949	1.141	22,3	12	9,5	840	-	1.240	8	0,28	2,4	3,6	2,5	1.920
241-800.ECA.W33	241-800.ECA.K30.W33		1.280	475	21.372	40.095	2.297	133	190		930	1.111	22,3	12	9,5	840	-	1.240	8	0,35	1,9	2,9	1,8	2.300
232-800.CAF.W33	232-800.CA.KF.W33		1.420	488	24.724	42.570	2.337	171	266		995	1.218	22,3	12	15	858	-	1.362	12	0,33	2	3	2	3.280
238-850.CAMA.W20	238-850.CA.KMA.W20	850	1.030	136	3.844	9.900	624	247	504	850	912	981	-	12	5	868	-	1.012	4	0,11	6,1	9,1	6,3	240
239-850.CA.W33	239-850.CA.K.W33		1.120	200	7.002	15.444	921	247	456		946	1.046	22,3	12	6	873	-	1.097	5	0,16	4,2	6,3	4	560
249-850.CA.W33	249-850.CA.K30.W33		1.120	272	9.297	22.572	1.357	209	380		940	1.029	22,3	12	6	873	-	1.097	5	0,22	3	4,6	2,8	740
230-850.CA.W33	230-850.CA.K.W33		1.220	272	11.179	21.384	1.238	228	428		972	1.117	22,3	12	7,5	878	-	1.192	6	0,2	3,4	5	3,2	1.050
240-850.ECA.W33	240-850.ECA.K30.W33		1.220	365	15.032	31.185	1.881	190	342		957	1.088	22,3	12	7,5	878	-	1.192	6	0,27	2,5	3,7	2,5	1.410
241-850.ECAF.W33	241-850.ECA.K30F.W33		1.360	500	23.589	44.550	2.475	124	181		988	1.182	22,3	12	12	898	-	1.312	10	0,35	1,9	2,9	1,8	2.770
232-850.CAF.W33	-		1.500	515	27.360	47.520	2.574	152	247		1.049	1.284	22,3	12	15	908	-	1.442	12	0,33	2	3	2	3.940
248-900.CAMA.W20	248-900.CA.K30MA.W20	900	1.090	190	5.374	15.147	941	228	456	900	969	1.029	-	12	5	918	-	1.072	4	0,14	4,8	7,2	4,5	370
239-900.CA.W33	239-900.CA.K.W33		1.180	206	7.576	16.830	990	228	428		996	1.101	22,3	12	6	923	-	1.157	5	0,15	4,5	6,7	4,5	605
230-900.CA.W33	230-900.CA.K.W33		1.280	280	11.882	22.968	1.307	209	380		1.025	1.176	22,3	12	7,5	928	-	1.252	6	0,2	3,4	5	3,2	1.200
240-900.ECA.W33	240-900.ECA.K30.W33		1.280	375	16.024	34.155	2.020	181	323		1.015	1.149	22,3	12	7,5	928	-	1.252	6	0,26	2,6	3,9	2,5	1.570
241-900.ECAF.W33	241-900.ECA.K30F.W33		1.420	515	25.057	48.510	2.673	114	171		1.043	1.235	22,3	12	12	948	-	1.372	10	0,35	1,9	2,9	1,8	3.350
239-950.CA.W33	239-950.CA.K.W33	950	1.250	224	8.520	19.404	1.109	209	409		1.056	1.164	22,3	12	7,5	978	-	1.222	6	0,15	4,5	6,7	4,5	755
249-950.CA.W33	249-950.CA.K30.W33		1.250	300	10.594	25.740	1.485	171	323		1.051	1.150	22,3	12	7,5	978	-	1.222	6	0,21	3,2	4,8	3,2	1.020
230-950.CA.W33	230-950.CA.K.W33		1.360	300	14.220	28.215	1.584	190	361		1.086	1.246	22,3	12	7,5	978	-	1.332	6	0,2	3,4	5	3,2	1.450
240-950.CAF.W33	240-950.CA.K30F.W33		1.360	412	17.669	38.610	2.218	162	285		1.077	1.214	22,3	12	7,5	978	-	1.332	6	0,27	2,5	3,7	2,5	1.990
241-950.ECAF.W33	241-950.ECA.K30F.W33		1.500	545	27.614	54.450	2.970	105	152		1.102	1.305	22,3	12	12	998	-	1.452	10	0,35	1,9	2,9	1,8	3.540

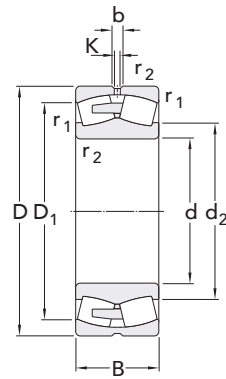

Cylindrical bore

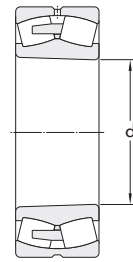

Tapered bore

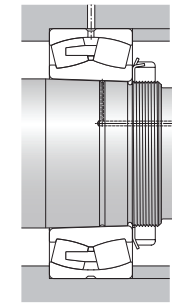
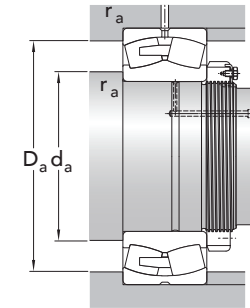

Dimension table

Designation		Main dimensions			Basic load ratings		Fatigue load limit Pu kN	Speed ratings		Dimensions					Mounting dimensions				Calculation factors			Mass kg	
Bearing with cylindrical bore	Bearing with tapered bore	d mm	D	B	C	C0		Reference speed r/min	Limiting speed	d	d2 =	D1 =	b	K	r1,2 min	da min	da max	Da max	ra max	e	Y1		Y2
–	–	mm			kN		kN	r/min	mm						mm				–				kg
238-1000.CAMA.W20	238-1000.CA.KMA.W20	1.000	1.220	165	5.351	14.157	842	209	380	1.079	1.161	–	12	6	1.023	–	1.197	5	0,12	5,6	8,4	5,6	410
249-1000.CA.W33	249-1000.CA.K30.W33		1.320	315	11.820	28.710	1.446	162	304	1.109	1.212	22,3	12	7,5	1.028	–	1.292	6	0,21	3,2	4,8	3,2	1.200
240-1000.CAF.W33	240-1000.CA.K30F.W33		1.420	412	18.407	40.095	2.218	152	266	1.136	1.278	22,3	12	7,5	1.028	–	1.392	6	0,26	2,6	3,9	2,5	2.140
231-1000.CAF.W33	231-1000.CA.KF.W33		1.580	462	25.394	47.520	2.525	133	266	1.185	1.403	22,3	12	12	1.048	–	1.532	10	0,28	2,4	3,6	2,5	3.500
241-1000.ECAF.W33	241-1000.ECA.K30F.W33		1.580	580	30.863	61.380	3.317	95	143	1.159	1.373	22,3	12	12	1.048	–	1.532	10	0,35	1,9	2,9	1,8	4.300
238-1060.CAMA.W20	–	1.060	1.280	165	5.500	14.850	857	190	361	1.137	1.219	–	12	6	1.083	–	1.257	5	0,11	6,1	9,1	6,3	435
239-1060.CAF.W33	239-1060.CA.KF.W33		1.400	250	11.220	25.740	1.416	171	342	1.171	1.305	22,3	12	7,5	1.088	–	1.372	6	0,16	4,2	6,3	4	1.100
249-1060.CAF.W33	249-1060.CA.K30F.W33		1.400	335	13.221	32.175	1.782	152	266	1.168	1.286	22,3	12	7,5	1.088	–	1.372	6	0,21	3,2	4,8	3,2	1.400
240-1060.CAF.W33	240-1060.CA.K30F.W33		1.500	438	20.517	45.045	2.426	143	247	1.199	1.349	22,3	12	9,5	1.094	–	1.466	8	0,26	2,6	3,9	2,5	2.520
249-1120.CAF.W33	249-1120.CA.K30F.W33	1.120	1.460	335	13.581	34.155	1.812	133	247	1.231	1.350	22,3	12	7,5	1.148	–	1.432	6	0,2	3,4	5	3,2	1.500
240-1120.CAF.W33	240-1120.CA.K30F.W33		1.580	462	22.141	49.500	2.673	124	228	1.268	1.423	22,3	12	9,5	1.154	–	1.546	8	0,26	2,6	3,9	2,5	2.930
238-1180.CAFA.W20	238-1180.CA.KFA.W20	1.180	1.420	180	6.711	18.414	1.070	162	304	1.264	1.355	–	12	6	1.203	–	1.397	5	0,11	6,1	9,1	6,3	575
239-1180.CAF.W33	239-1180.CA.KF.W33		1.540	272	12.946	30.690	1.644	143	285	1.305	1.439	22,3	12	7,5	1.208	–	1.512	6	0,16	4,2	6,3	4	1.400
249-1180.CAF.W33	249-1180.CA.K30F.W33		1.540	355	15.594	40.095	2.139	124	228	1.297	1.422	22,3	12	7,5	1.208	–	1.512	6	0,2	3,4	5	3,2	1.800
240-1180.CAF.W33	240-1180.CA.K30F.W33		1.660	475	25.217	57.915	3.020	124	209	1.325	1.507	22,3	12	9,5	1.200	–	1.626	8	0,26	2,6	3,9	2,5	3.320
230-1250.CAF.W33	230-1250.CA.KF.W33	1.250	1.750	375	21.044	44.550	2.297	124	228	1.415	1.611	22,3	12	9,5	1.284	–	1.716	8	0,19	3,6	5,3	3,6	2.840
249-1320.CAF.W33	249-1320.CA.K30F.W33	1.320	1.720	400	18.527	48.510	2.475	105	190	1.449	1.589	22,3	12	7,5	1.348	–	1.692	6	0,21	3,2	4,8	3,2	2.500
248-1500.CAFA.W20	248-1500.CA.K30FA.W20	1.500	1.820	315	14.538	44.550	2.376	105	209	1.500	1.612	–	12	7,5	1.528	–	1.792	6	0,15	4,5	6,7	4,5	1.710
248-1800.CAFA.W20	248-1800.CA.K30FA.W20	1.800	2.180	375	20.072	62.370	3.020	72	133	1.932	2.060	–	12	9,5	1.834	–	2.146	8	0,15	4,5	6,7	4,5	2.900



WE ARE
HERE

www.evolve.com
info@evolve.com

Tel: +39 0385 250895

Sede operativa / Head office: Via dei Marinoni, 37 – 27040 Cigognola (PV) – ITALY

Sede Legale / Registered office: Via Trento, 73 – 27049 Stradella (PV) – ITALY



EVOLMEC products meet all the international requirements for quality.
Our Quality Management System has been developed in accordance with **ISO 9001:2015**

In this way we can ensure **high-quality** processes and products to meet the specific needs of each of our clients