

INDUSTRY LUBRICATION



www.ntn-snr.com



With You

Experts & Tools

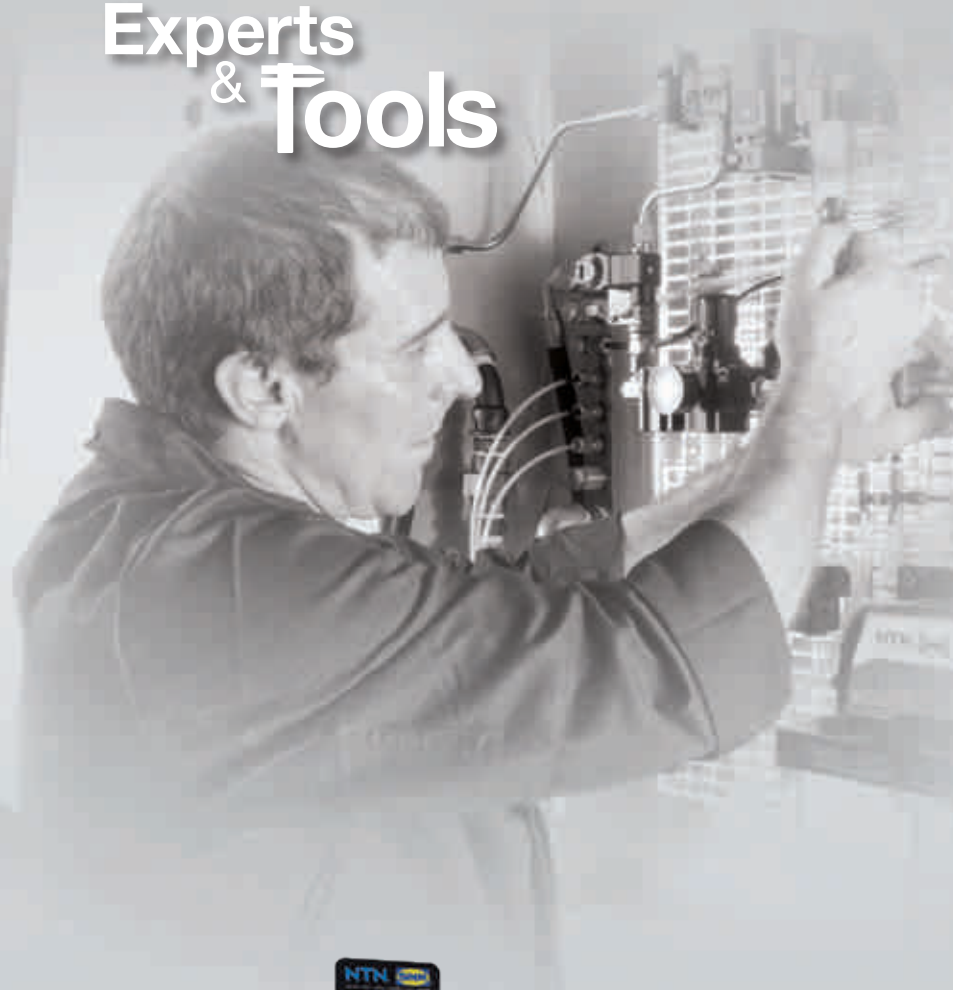



« Providing you with a complete range of tools and services for your bearings, adapted to your application, size and resources »

Experts
& Tools

NTN-SNR Experts & Tools, working to serve our customers.

Every customer has specific expectations in terms of bearing maintenance and lubrication, therefore NTN-SNR Experts & Tools offers solutions designed for your application and priorities, not forgetting budget.

Every application requires specific expertise. Wind turbine maintenance differs from press or crusher maintenance. NTN-SNR is able to provide the expertise and tools you need thanks to almost one century of theory and practice in everyday contact with industrial applications.

Our recommendations will be based on the scale and difficulty of your maintenance and lubrication operations of your units. We provide customised solutions in terms of tools or organisation depending on your situation.

With nearly 18,000 employees working throughout the world, NTN-SNR prepares and improves maintenance methods and tools on a daily basis. Our aim is to provide easy-to-implement products and services. When we design our tools and organise our services, we aim to improve your effectiveness. From reducing the duration of maintenance and servicing operations to optimising the life cycle of your bearings, our services can lead to real benefits, improve safety and extend service lives.

This catalogue includes our full range of greases, automatic lubricator and centralised lubrication systems, plus our related services. Our maintenance tools are listed in a separate catalogue. (See opposite)



LUB'SOLUTIONS, let us solve your lubrication problems

All bearings, mechanical parts and industrial processes need reliable and suitable lubrication to operate in an optimal and long-term manner. In addition to supplying quality bearings, NTN-SNR is aware of the critical nature of lubrication for your applications, and can provide its expertise and products to manage this fundamental issue.

The LUB'SOLUTIONS product range includes lubricants specially selected for various applications, and all items you may need to reliably distribute and apply just the right amount of lubricant each mechanical part requires.

However, **LUB'SOLUTIONS is above all a team of experts** ready to assist you in implementing the right solutions for your environment. Our technicians are available to solve your problems, from providing advice in defining your requirements to installing lubrication systems for your application, including made-to-measure projects.

LUB'SOLUTIONS, the Experts & Tools way of thinking. Our experts are available and determined to provide you with customised solutions to ensure that your bearings and machines operate in optimal conditions, applying their Experts & Tools way of thinking.

GENERAL CONTENTS

P.5 1. LUBRICANTS

- Greases or oils and your choice 6



P.15 2. LUBRICATION SYSTEMS

- Manual lubrication : grease or oil gun 16
- Automatic lubrication :
 - READY Booster* 18
 - SMART Booster* 20
 - DRIVE Booster* 22
 - Accessories for the Booster range* 24
- Multi-point greasing:
 - POLIPUMP: centralised lubrication for everyone* 26



P.30 3. LUBRICATION THEORY AND METHODS

- LUB'SOLUTIONS services 31
- Lubrication requirement design tools 32

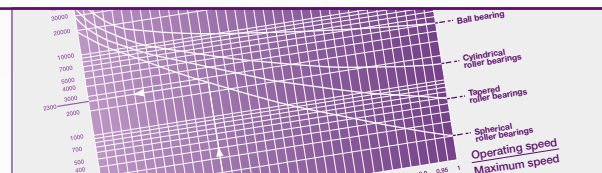

P.35 4. PRODUCT TECHNICAL DATA

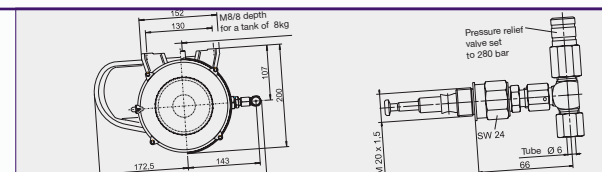





P.6 1. LUBRICANTS

- Greases or oils and your choice

6

1. LUBRICANTS

WHAT THE EXPERTS SAY:

▶ Only appropriate lubrication can guarantee the optimal operation of bearings and the related mechanical assembly.

55% of premature bearing failure is caused by inappropriate lubrication.

Inadequate lubrication will substantially shorten the service life of the bearing.

Bearing lubrication is often neglected due to the difficulty of accessing bearings and the operator's lack of lubricant knowledge.

Selecting the right lubricant, the right lubrication method, the precise quantity required for the bearing and the frequency of monitoring the lubrication are all critical points.

A. PRINCIPLE AND BENEFITS OF GOOD LUBRICATION

- A film of lubricant (oil film) between the balls or rollers and the bearing raceway prevents **wear and seizure**.
- Lubrication protects components **from corrosion**.
- Lubrication also protects the components **from liquids** and external pollution, and evacuates wear debris.
- Lubrication reduces **friction**, reducing the power consumed by the machine, and thereby providing **energy savings**.
- Circulating oil distributes heat and contributes to the thermal equilibrium of the machine.

The service life of the bearing is directly related to the effectiveness of the oil film, which depends on:

- the type of lubricant; its specific heat capacity, resistance to vibrations, etc.
- the load and speed of the bearing.

Greases for general use do not always meet the specific requirements of some applications. Bearings requested to operate in specific load, speed or temperature conditions, or in the presence of water, humidity or vibrations, require the use of carefully selected grease.

NTN-SNR has carried out research in this field with the leading international lubricant manufacturers for more than half a century. We therefore have knowledge and practical experience for most lubricants used with bearings.

B. SELECTING YOUR TYPE OF LUBRICATION

	OIL LUBRICATION	GREASE LUBRICATION
ADVANTAGES	<ul style="list-style-type: none"> • Good penetration into the bearing • Good physical and chemical stability • Cooling • Easy lubricant control: volume and level 	<ul style="list-style-type: none"> • Clean mechanisms • Simplified sealing • Protection • Simple assembly • Easy handling • Reduced or no lubricant replacement required • Option to use pre-greased bearings
DISADVANTAGES	<ul style="list-style-type: none"> • Sealing required for assembly • Inadequate protection against corrosion and humidity in case of extended periods of non-running • Time delay, if it is necessary to start independent circulation prior to rotation of the bearing 	<ul style="list-style-type: none"> • Higher friction coefficient than oil • Reduced heat transfer • The bearing must be dismantled and washed in order to be replaced (if necessary) • No option to check the level of grease, therefore grease levels must be reliable or periodic top-up is required to compensate for leaks, pollution and aging

C. GREASE CHARACTERISTICS

Grease is a product with a semi-fluid to solid consistency, obtained by blending a thickening agent (soap) with a liquid lubricant (mineral or synthetic oil).

Additives may be included to obtain specific properties. The growing use of grease-lubricated bearings, combined with the development of 'greased for life' lubrication, makes grease a critical element in the bearing. The service life of the bearing and its behaviour in various environments significantly depend on the properties of the grease used.

Physical and chemical characteristics:

Consistency

- NLGI (National Lubrication Grease Institute) grades correspond to a value of worked penetration in the grease (according to test specification ASTM/D217)
- For bearings, the consistency generally adopted is grade 2 (normal).

Viscosity of basic oil: generally defined in cSt (mm²/S) at 40°C.

Density: approx. 0.9

Drop point: the temperature at which the first drop of a sample liquefied by heating drips.

Approximately: 180°C/260°C depending on the composition of the grease. The maximum service temperature of the grease is always well below the drop point.

NLGI GRADES	WORKED PENETRATION	CONSISTENCY
0 1	385 - 355 340 - 310	Semi-fluid Very soft
2 3	295 - 265 250 - 220	Soft Normal
4	205 - 175	Firm

Functional characteristics

The working conditions imposed on the lubricant (rolling, mixing) require special greases for bearings which cannot be selected simply on the basis of their physical and chemical characteristics.

The NTN-SNR Research and Test Centre is continuously testing to approve bearings, enabling us to offer advice on the most suitable grease for each application.

Approval specifications are based on the following criteria:

- endurance for ball bearings
- endurance for roller bearings
- water resistance
- resistance to high and low temperatures
- adhesion (centrifugation)
- resistance to vibrations (false brinelling)
- resistance to high speeds
- etc.

Other criteria can be added depending on the final results required by the customer. Selecting a type of grease will represent the best compromise based on the specifications for the application.

D. TECHNICAL CHARACTERISTICS OF LUBRICANTS AND MAKING A CHOICE

The grease will be selected on the basis of operating conditions, which must be defined as precisely as possible: temperature, speed, load, environment, vibrations and any other specific limitations inherent to the application.

Select which grease to use with the assistance of your NTN-SNR contact.

The table on the pages 12 & 13 provides initial guidance.

1. LUBRICANTS



UNIVERSAL Multi purpose



Grease for general usage, in industry or for automobiles.

10

STANDARD APPLICATIONS

Agricultural equipment, washing machines, handling equipment, general mechanical devices, low-power electric motors, car wheel bearings, small tools, etc.

BENEFITS

Good properties in the presence of water, excellent protection against wear and corrosion.

TEMPERATURE RANGE

from -25°C to +140°C



HEAVY DUTY High Load



Top quality grease for very high-pressure applications, suitable for many applications, intended for arduous applications in heavy industry: metallurgy, construction, transport, etc.

10

STANDARD APPLICATIONS

Conveyors, lifting devices, truck wheel hubs, high-power electric motors, water pumps, presses, etc.

BENEFITS

Excellent performance under heavy loads, including high speeds, good properties in the presence of water, excellent protection against wear and corrosion.

TEMPERATURE RANGE

from -25°C to +140°C



VIB Vibrations & Shocks



This grease is an ideal lubricant for parts subjected to extensive vibrations or impact.

Recommended for quarries, cement plants, public works and agricultural operations, high-load applications in humid environments, paper plants, boring, etc.

11

STANDARD APPLICATIONS

Shafts in scoops, crushers, grinders, vibrating scalpers, washing machines, industrial fans, etc.

BENEFITS

Excellent resistance to impact, vibrations and heavy loads, excellent resistance to water guaranteeing long-term lubrication.

TEMPERATURE RANGE

from -20°C to +140°C



HIGH TEMP MP High temperature



This grease is the ideal solution for long-term lubrication at low and high temperatures up to +180°C.

11

STANDARD APPLICATIONS

Electric motors, dryers, oven conveyors, generators, pumps, textile machines, paper converting machines...

BENEFITS

Extreme pressure polyurea multi-purpose grease that offers excellent protection against wear and corrosion. Quiet, it is perfect for the lubrication of electric motor bearings.

TEMPERATURE RANGE

from -40°C to +180°C



FOOD AL Food Sure

Multi-purpose grease for the food and pharmaceutical industries. Complies with NSF-H1* recommendations*.

11



STANDARD APPLICATIONS

At any point where accidental contact with food is technically possible. Bottling machines, dairy equipment, industrial baking, pasta manufacturing, confectionery, slaughterhouses, etc.

BENEFITS

Wide range of service temperatures, good protection against corrosion, good resistance to washing with hot and cold water, and many disinfectant solutions and detergents.

TEMPERATURE RANGE

from -25°C to +120°C

* NSF: National Sanitation Foundation /H1: Occasional contact with food.



FOOD CHAIN OIL

Food-grade oil for chains designed for the food-processing and pharmaceutical industry. Complying with NSF-H1* recommendations.

11



STANDARD APPLICATIONS

Straight, bevel and worm gearing, main bearings, pivots, articulations as well as for the lubrication of lifting, drive and transmission chains even at low temperatures.

ADVANTAGES

Wide range of operating temperatures, remains very stable over time and resists oxidation, good protection against wear and corrosion as well as a resistance to seizing. Neutral in relation to sealants and paints.

TEMPERATURE RANGE

-30°C to +120°C

* NSF: National Sanitation Foundation/H1: occasional contact with food.



CHAIN OIL

Synthetic oils for high-temperature chains.

11



STANDARD APPLICATIONS

Textile and plastic injection machines: in levelling equipment, stenter frames, multi-layer systems, festoon dryers, festoon steamers and coating units.

For all types of stenter chains lubricated with oil (roller chains, clips with ball bearings, sliding with guide bar) and chain/chain shaft articulations.

BENEFITS

Excellent lubrication, even with the presence of high temperatures and loads, excellent spreading properties, ensuring the rapid formation of a film of lubrication, excellent resistance to loads and wear, good adhesion therefore no spray, little formation of residue thanks to 100% synthetic components.

TEMPERATURE RANGE

from -20°C to +250°C



ULTRA HIGH TEMP - Extreme High Temperature

This grease is for long-term lubrication for any type of bearing subjected to extreme temperatures. Registered H1: can be used in food-processing industries.

11



STANDARD APPLICATIONS

Textile drying machines, corrugated board production units, the plastic industry, rolling tail pipes, copy machines, furnace equipment, kiln cars, electric motors operating at extreme temperatures, etc.

BENEFITS

For very high service temperatures up to +260°C, good ability to absorb pressure, excellent resistance to aggressive agents, compatible with most plastics and seals.

TEMPERATURE RANGE

from -30°C to +260°C



HIGH SPEED + Spindles

Low-temperature grease for very high speeds.

11



STANDARD APPLICATIONS

Textile machine spindles, spindles in power-operated tools running at high speeds (milling shafts, lathes, grinders, drills, etc.)

BENEFITS

Reduced running-in time for spindle bearings, excellent resistance to water (protects against the premature failure of bearings and reduces maintenance costs), reduced bearing temperature due to low friction torque (extended bearing service life), synthetic oil + low-viscosity ester ensuring a wide range of service temperatures and excellent cold temperature resistance.

TEMPERATURE RANGE

from -45°C to +120°C

1. LUBRICANTS

GREASE CHARACTERISTICS

(physical, chemical and mechanical properties, packaging)

Lubricants: description	UNIVERSAL	UNIVERSAL +	HEAVY DUTY	HEAVY DUTY +
NLGI consistency grade	2	2	2	2
Base oil	Mineral	Mineral	Mineral	Mineral
Thickener / type of soap	Lithium	Lithium / Calcium	Lithium with EP additives	Lithium with EP additives
Colour	Amber	Light Brown	Amber	Brown
Base oil viscosity (cSt) - at 40°C	115	220	115	150
- at 100°C	11	6,5	11	15
Service temperature range (°C)	From -25 to +140	From -30 to +130	From -25 to +140	From -30 to +150
Drop point (°C) DIN ISO2176	> 190	> 170	> 190	> 190
Suitable for medium loads P<C/5		+		++
Suitable for high loads P<C/5		-		++
Suitable for low speeds n.Dm <100,000		+		+
Suitable for high speeds n.Dm >100,000		+		+
Properties in humid environments, in the presence of water		++		++
Suitable for low-amplitude oscillations		+		+
Suitable for vibrations when shutdown		-		-
Adhesion		+		+
Low torque		+		+
Low noise levels		+		+
Anti-corrosion protection		++		++
Resistance to chemical agents		-		-
Pumpability		++		++
Sizes available	400 g cartridge 1 kg can 5 kg bucket 23 & 50 kg drums	Lubricator BOOSTER	400 g cartridge 1 kg can 5 kg bucket 23, 50 and 190 kg drums	Lubricator BOOSTER
Remarks	Previous name: MS		Previous name: EP	

N.Dm: rpm x mean diameter (millimetres)

- ++ Excellent performance
- + Good performance
- Not recommended
- / Not applicable

VIB	HIGH TEMP MP	FOOD AL / FOOD	FOOD CHAIN OIL	CHAIN OIL	ULTRA HIGH TEMP	HIGH SPEED +
2	2	2	/	/	2	2
Semi-synthetic	Synthetic	Paraffinic mineral / PAO	Ester + PAO	Ester + PAO	Perfluorinated polyether synthetic	Ester + SHC
Lithium /Calcium	Polyurea	Aluminium complex	/	/	PTFE	Lithium /Calcium
Light Brown	Pale Yellow	Pale yellow	Colourless	Pale green	White	Light brown
360	80	248 / 195	220	320 (*)	460	25
25	12	24 / 22	26	28 (*)	40	5.8
From -20 to +140	From -40 to +180	From -25 to +120 / -30 to +120	-30 à +120	From -20 to +250	From -30 to +260	From -45 to +120
> 190	> 260	> 200 / > 220	Pour Point <-30	Pour Point -25	Not measurable (*)	> 180
+	+	+	/	/	++	+
++	+	+	/	/	++ (**)	-
++	+	+	/	/	++	-
-	+	+	/	/	+	++
+	++	+	/	/	+	++
++	++	+	/	/	++	+
-	-	-	/	/	-	++
++	++	+	/	/	++	+
-	+	+	/	/	-	++
-	++	-	/	/	-	++
+	+	+	/	/	+	++
-	-	-	/	/	++	-
++	++	++	/	/	++	++
400 g cartridge 1 kg can 50 kg drum Lubricator BOOSTER	400 g cartridge 1 kg can Lubricator BOOSTER	Food AL: 400 g cartridge 1 kg can Food: Lubricator BOOSTER	READY BOOSTER	Lubricator BOOSTER	800 g cartridge	1 kg can
Previous name: VX	Previous name: HIGH TEMP	Meets NSF requirements as an H1 product	Meets NSF requirements as an H1 product	*Base oil viscosity at 20°C = 1200cSt	* According to standard DIN 2176, the drop point of this grease cannot be determined, i.e. this grease fails to melt **If T<200°C Meets NSF H1 requirements.	Pay attention to quantity, and grease levels

1. LUBRICANTS

E. SELECTING AN NTN-SNR GREASE SUITABLE for your applications

PREVAILING OPERATION	OPERATING LIMITS		EXAMPLES OF APPLICATIONS
	TEMPERATURE °C	SPEED	
General usage	UNIVERSAL -25 to +140 UNIVERSAL + -30 to +130	< maximum bearing speed	Industry and automobile: Agricultural equipment, general mechanical devices, handling equipment, electrical tools, car wheel bearings, etc.
High loads	HEAVY DUTY -25 to +140 HEAVY DUTY + -30 to +150	< 2/3 maximum bearing speed	Arduous applications in heavy industry: Iron and steel, construction, transport, conveyors, lifting devices, high-power electric motors, water pumps, presses, truck wheel hubs, etc.
High temperature	-40 to +180	< 2/3 maximum bearing speed	Automotive, steel, paper, bearings for electric motors, pumps, dryers, furnace conveyors, generators, and many other high temperature applications.
	-30 to +260	< 2/3 maximum bearing speed	Corrugated board production, the plastic industry, textile drying machines, rolling tail pipes, copy machines. Electric motors operating at very high temperatures, furnace equipment, kiln cars, etc. Registered H1: can be used in food-processing industries.
Low temperature	Down to -45	< 2/3 maximum bearing speed	Aviation, special devices.
High speed	-20 to +120	< 4/3 maximum bearing speed	Machine tool spindles, textile machine spindles, miniature electric motors.
Humidity	-30 to +140	< 2/3 maximum bearing speed	Washing machines.
High-amplitude impacts or vibrations Centrifugation Rotating outer ring	-20 to +130	< 2/3 maximum bearing speed	For quarries, cement plants, public works and agricultural operations, high-load applications in humid environments, paper plants, drilling and boring. Shafts in scoops, crushers, grinders, vibrating scalpers, washing machines, industrial fans, etc.
Food usage	-25 to +120	< 2/3 maximum bearing speed	Applications where accidental contact with food is technically possible: Bottling machines, dairy equipment, industrial baking, pasta manufacturing, confectionery, slaughterhouses, etc.
Use in food processing Chain oil	-30 to +120	/	Applications in the food and pharmaceutical industry: Straight, bevel and worm gearing, main bearings, pivots, articulations as well as for the lubrication of lifting, drive and transmission chains even at low temperatures.
High-temperature chain oil	-25 to +250	/	Applications in the textile and plastics industries with all types of oil-lubricated chains: Levelling machines, stenter frames, multi-layer systems, festoon steamers, dryers, coating units.



TYPICAL RECOMMENDATIONS	EXPERTS & TOOLS RECOMMENDATIONS
<p>Mineral oil. Traditional soap (lithium, calcium, etc.). Grade 2 consistency is generally used for large bearings or bearings with specific operating properties. Reduced performance above 90°C (continuous).</p>	<p>UNIVERSAL or UNIVERSAL +</p>
<p>Similar to general purpose greases with extreme pression additives.</p>	<p>HEAVY DUTY or HEAVY DUTY +</p>
<p>Synthetic polyurea multi-purpose grease for high speeds, low and high temperatures containing no substances harmful to human health or the environment.</p>	<p>HIGH TEMP MP</p>
<p>Completely synthetic grease. The grease is not miscible with mineral and synthetic based products of different types. The proper operational efficiency of this product can only be achieved when the components to be lubricated are thoroughly clean and free from other grease. H1 registrations: occasional contact with food.</p>	<p>ULTRA HIGH TEMP</p>
<p>Base oil with very low viscosity. Important: the grease becomes fluid if temperature >80°C.</p>	<p>HIGH SPEED +</p>
<p>Oil with very low viscosity.</p>	
<p>Traditional grease doped with anti-corrosion additive.</p>	<p>UNIVERSAL or HEAVY DUTY (normal or +)</p>
<p>Grease with grade 2 consistency and high adhesion.</p>	<p>VIB</p>
<p>Meets NSF requirements as an H1 product. *NSF: National Sanitation Foundation /H1: Occasional contact with food.</p>	<p>FOOD AL</p>
<p>Meets NSF requirements as an H1 product. *NSF: National Sanitation Foundation /H1: Occasional contact with food.</p>	<p>FOOD CHAIN OIL</p>
<p>Oil with good adhesion and good creep properties (spreading).</p>	<p>CHAIN OIL</p>

1. LUBRICANTS

GREASE COMPATIBILITY

It is not generally advised to mix two lubricating greases.

If two greases are mixed (e.g.: when grease is changed in a lubrication system), check the compatibility of the two greases, i.e. of their base oils and their thickeners.

OIL	MINERAL	PAO POLY ALPHA-OLEFIN	ESTER	P. POLY GLYCOL	POLYPHENYL ETHER	SILICONE (METHYL)	SILICONE (PHENYL)	FLUORINATED
MINERAL	C							
PAO POLY ALPHA-OLEFIN	C	C						
ESTER	C	C	C					
P. POLY GLYCOL	NC	NC	C	C				
POLYPHENYL ETHER	C	C	C	NC	C			
SILICONE (METHYL)	NC	NC	NC	NC	NC	C		
SILICONE (PHENYL)	C	C	C	NC	C	C	C	
FLUORINATED	NC	NC	NC	NC	NC	NC	NC	C

LEGEND C : Compatible - NC : Not Compatible.

THICKENER	ANHYDROUS CALCIUM SOAP	CALCIUM COMPLEX SOAP	LITHIUM SOAP	LITHIUM COMPLEX SOAP	LITHIUM / CALCIUM SOAP	ALUMINIUM COMPLEX SOAP	BENTONE SILICA GEL	POLYUREA	FLUORINATED
ANHYDROUS CALCIUM SOAP	C								
CALCIUM COMPLEX SOAP	NC	C							
LITHIUM SOAP	C	NC	C						
LITHIUM COMPLEX SOAP	C	C	C	C					
LITHIUM / CALCIUM SOAP	C	NC	C	C	C				
ALUMINIUM COMPLEX SOAP	C	NC	NC	NC	NC	C			
BENTONE SILICA GEL	C	NC	NC	NC	NC	NC	C		
POLYUREA	C	C	C	C	NC	C	NC	C	
FLUORINATED	NC	NC	NC	NC	NC	NC	NC	NC	C

LEGEND C : Compatible - NC : Not Compatible.



P.15 2. LUBRICATION SYSTEMS

- Manual lubrication : grease or oil gun 16
- Automatic lubrication :
 - READY Booster* 18
 - SMART Booster* 20
 - DRIVE Booster* 22
 - Accessories for the Booster range* 24
- Multi-point greasing:
 - POLIPUMP: centralised lubrication for everyone* 26

MANUAL

GREASE OR OIL GUN

Easy one-handed lubrication.

36

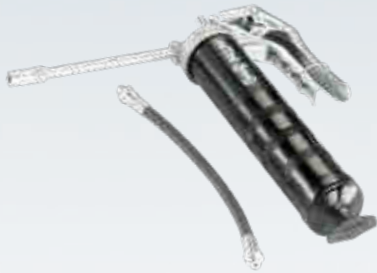

*Optional

APPLICATIONS

The grease gun is the ideal tool for easy, clean and quick greasing in industrial and agricultural environments.

BENEFITS

• Practical

The pump can be operated with one hand.
Easy grip thanks to the knurled casing.
Can be used either with cartridges or filled directly with grease.

• Robust

Designed for industrial applications with a maximum pressure of 345 bar.
The high quality impact-proof steel guarantees long-life.

• Clean and precise application

The special grease nozzle developed by NTN-SNR can be screwed to the grease gun.
Use this nozzle to inject grease cleanly and precisely into the bearing.
Slow and controlled grease flow: 0.5 cm³ /travel

PRODUCT NAME

LUB GREASE GUN SET

Cap (in option): LUB GREASE GUN/ACC SET

MONOPOINT

WHAT THE EXPERTS THINK

Reduce your maintenance times and operating costs while improving safety for your personnel and machines.

The automatic lubricator can be used to ensure the constant and regular lubrication of your bearings. The lubricator is easy to integrate into various applications (mechanical and automobile industries, steelworks, paper plants, etc.), and can be used to optimise lubrication without any need to modify your installations.

AUTOMATIC LUBRICATORS CAN BE USED TO ACHIEVE CONTINUOUS, RELIABLE, CLEAN AND EXTREMELY PRECISE LUBRICATION FOR YOUR BEARINGS:

- They provide a constant and controlled supply of quality grease, 24 hours a day, 7 days a week.
> **Less friction = energy savings**
- They actively contribute to extending the service cycle of the bearings.
> **They improve the reliability of industrial equipment**
- They eliminate the risk of excessive or inadequate lubrication.
- They reduce the risk of contamination.
- They guarantee the right lubrication with the right grease.
> **Reducing the number of premature failures**
- They can be used to extend mean time between maintenance operations on the machine.
> **Reducing the risks of accidents, particularly in dangerous or difficult-to-access areas**

CHOOSE THE MOST APPROPRIATE AUTOMATIC LUBRICATOR and grease for your applications



UNIVERSAL +



HEAVY DUTY +



VIB



HIGH TEMP MP



FOOD



FOOD CHAIN OIL



CHAIN OIL

DESCRIPTION

General purpose grease for industrial use.

Suitable for very high loads, compatible with many applications, intended for arduous applications.

Parts subject to extensive vibrations or impact. For high-load applications in humid environments.

This grease is ideal for long-term lubrication at high temperatures up to +180°C.

Multi-purpose grease for the food and pharmaceutical industries. Complies with NSF-H1 recommendations.

Food-grade oil for chains designed for the food-processing and pharmaceutical industry. Complying with NSF-H1 recommendations.

Synthetic oils for high temperature chains.

APPLICATIONS

Agricultural equipment, handling equipment, general mechanical devices, low-power electric motors, etc.

Heavy industry: metallurgy, construction, transport, conveyors, lifting devices, water pumps, etc.

Quarries, cement works, public works and humid environments: paper works, boring, crushers, vibrating scalpels, etc.

Textile machinery, paper processing, hot fans, dryers, electric motor.

Bottling machines, dairy equipment, industrial baking, pasta manufacturing, confectionery, slaughterhouses, etc.

Straight, bevel and worm gearing, main bearings, pivots, articulations as well as for the lubrication of lifting, drive and transmission chains even at low temperatures.

Textile and plastic materials transformation machines: for all types of chains, oil-lubricated reams.

TECHNICAL DATA

Soap	Lithium Calcium	Lithium	Lithium Calcium	Polyurea	Aluminium complex	•	•
Oil	Mineral	Mineral	Semi-synthetic	Synthetic	Paraffinic mineral	Ester + PAO	Ester + PAO
Service temperature	-30°C/+130°C	-30°C/+150°C	-20°C/+140°C	-40°C/+180°C	-30°C/+120°C	-30°C/+120°C	-20°C/+250°C
Viscosity at 40°C	220 cSt	150 cSt	360 cSt	80 cSt	195 cSt	220 cSt	320 cSt

PRODUCT RANGE

READY Booster	•	•	•	•	•	•	•
SMART Booster	•	•	•	•	•	•	•
DRIVE Booster	•	•	•	•	•	•	•



READY BOOSTER

- 60 cm³ and 125 cm³
- Low-cost
- Robust
- Ergonomic: excellent grease level visibility
- Can be used in explosive areas



SMART BOOSTER

- + capacity: 125 cm³
- Precise, ergonomic
- Adjustable discharge (in months) using an LCD
- Constant flow, regardless of ambient temperature
- Recyclable: re-usable control unit
- Suitable for explosive areas



DRIVE BOOSTER

- Polyvalent
- 2 sizes: 120 cm³ and 250 cm³
- Multi-purpose
- Precise
- Powerful: suitable for remote lubrication
- Rechargeable

2. LUBRICATION

1 / READY BOOSTER 60 & 125



This system is ideal for humid environments, exposed to corrosive environment or requiring optimised hygiene standards, just like in the food industry.

▶ 36

READY BOOSTER: robust and cost effective model.

A • DESCRIPTION

Available in 2 sizes (60cc and 125cc), the READY BOOSTER is suitable for a variety of applications, particularly harsh environments that can cause the corrosion of electronic systems or industrial sectors demanding high standards of cleanliness and hygiene.

The grease is pressurised by an inert gas generated by an electrochemical reaction.

The duration of the distribution of grease is adjustable from 1 to 12 months thanks to a selector.

B • APPLICATIONS

Designed for the single-point lubrication of plain or rolling element type bearings, open gears, chains, ball screws, linear guide bars, etc. The units resistance to corrosion makes it very popular in the food industry.





60 CC

125 CC



C • CHARACTERISTICS AND BENEFITS

<ul style="list-style-type: none"> • Compact design (flange optional). 	<ul style="list-style-type: none"> • Easy to install, even in confined locations.
<ul style="list-style-type: none"> • Certification   II 1G Ex ia IIC T6 II 1D Ex iaD 20 T85°C I M1 Ex ia I DEKRA 13 ATEX 0078 X 	<ul style="list-style-type: none"> • Can be used in explosive areas.
<ul style="list-style-type: none"> • Transparent tank in high density polyamide. 	<ul style="list-style-type: none"> • Easy to check grease level.
<ul style="list-style-type: none"> • Watertight and dustproof. 	<ul style="list-style-type: none"> • Corrosion and vibration resistant. • Can operate in all positions.
<ul style="list-style-type: none"> • Flow limiter valve integrated in the oil version. 	<ul style="list-style-type: none"> • Simple installation.

D • TECHNICAL DATA

Drive: **gas-operated with an electrochemical reaction**

Capacity: **60 cm³ or 125 cm³**

Max. pressure: **5 bar**

Duration of distribution: **1 to 12 months**

Immediate start-up: **1 day**

Service temperature: **from -20°C to +60°C**

Available with high-performance NTN-SNR greases specially developed for bearings and main bearings and also special synthetic oils for chains.

Contact us for other types of lubricants.

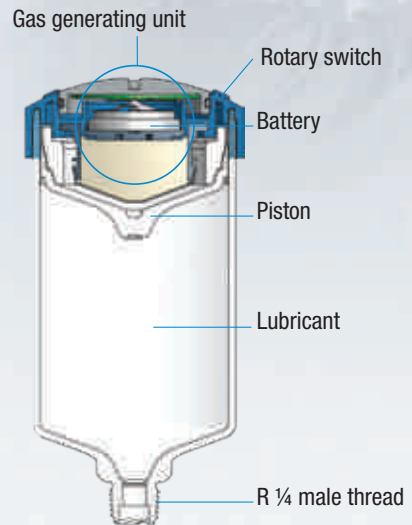

E • DESIGNATION

DESIGNATION	PRODUCT	LUBRICANT
LUBER READY 60 UNIVERSAL +	READY BOOSTER 60	Grease UNIVERSAL + (General usage)
LUBER READY UNIVERSAL +	READY BOOSTER 125	
LUBER READY 60 HEAVY DUTY +	READY BOOSTER 60	Grease HEAVY DUTY + (High loads)
LUBER READY HEAVY DUTY +	READY BOOSTER 125	
LUBER READY 60 HIGH TEMP MP	READY BOOSTER 60	Grease HIGH TEMP MP (High temperatures)
LUBER READY HIGH TEMP MP	READY BOOSTER 125	
LUBER READY 60 VIB	READY BOOSTER 60	Grease VIB (Vibrations and shocks)
LUBER READY VIB	READY BOOSTER 125	
LUBER READY 60 FOOD	READY BOOSTER 60	Grease FOOD (Compatible with food contact)
LUBER READY FOOD	READY BOOSTER 125	
LUBER READY FOOD CHAIN OIL	READY BOOSTER 125	Oil FOOD CHAIN OIL (Food-grade oil for chains)
LUBER READY 60 CHAIN OIL	READY BOOSTER 60	Oil CHAIN OIL (High performance for chains)
LUBER READY CHAIN OIL	READY BOOSTER 125	

2 / SMART BOOSTER 125



The advanced and low-cost lubrication solution, ideal for applications subject to temperature variations.

SMART BOOSTER: the low-cost model whatever the temperature.

A • DESCRIPTION

SMART BOOSTER, the first electrochemical Automatic Lubricator equipped with a reusable control unit, providing measured flow independent of the ambient temperature.

Guaranteed continuous lubricant flow, with the correct volume for your application, regardless of temperature.

This smart Automatic Lubricator is equipped with a temperature probe which adjusts pressure to distribute just the right amount of grease selected at start-up.

The duration of distribution is easy to adjust (from 1 to 12 months) simply by selecting the appropriate period on the control unit.

The control unit can be re-used several times, only the **125 cm³** grease cartridge requires replacement.





B • APPLICATIONS

Designed for the single-point lubrication of plain or rolling element type bearings, open gears, chains, ball screws, linear guide bars, etc. This model is ideal for environments facing substantial temperature variations (e.g: fans mounted under roofs) or requiring intrinsic safety (e.g: petrochemical industry).



C • CHARACTERISTICS AND BENEFITS

<ul style="list-style-type: none"> Adjustable between 1 and 12 months using the re-usable touchpad control unit, with an ON/OFF function. 	<ul style="list-style-type: none"> Flexible, precise and multipurpose, reducing operating costs while improving the lubrication of rotating parts.
<ul style="list-style-type: none"> Integrated temperature compensation with a wide range of service temperatures. 	<ul style="list-style-type: none"> High level of reliability: controlled grease flow, unaffected by temperature for the entire duration of distribution. Universal usage.
<ul style="list-style-type: none"> Compact design with reinforced flange. 	<ul style="list-style-type: none"> Robust, easy to install, even in confined locations.
<ul style="list-style-type: none"> Certification   I M1 Ex ia I Ma II 2G Ex ia IIC T4 Gb II 2D Ex ia IIC T 135°C Db ZELM IO ATEX 0434X 	<ul style="list-style-type: none"> Can be used in explosive areas.
<ul style="list-style-type: none"> Protection IP65. 	<ul style="list-style-type: none"> Can be used in many dusty and humid environments.
<ul style="list-style-type: none"> Transparent tank in high density polyamide. 	<ul style="list-style-type: none"> Easy to check grease level. Can operate in all positions.
<ul style="list-style-type: none"> Flow limiter valve integrated in the oil version. 	<ul style="list-style-type: none"> Simple installation.

D • TECHNICAL DATA

Drive: **gas generating cells with electronic temperature compensation**

Capacity : **125 cm³**

Max. pressure : **6 bar**

Duration of distribution : **1, 2, 3,...12 months**

Immediate start-up: **1 day**

Service temperature: **from -20°C to +60°C**

Available with advanced NTN-SNR greases, especially developed for bearings, and with special synthetic oil for chains. Contact us for other types of lubricants.

E • DESIGNATION

LUBER SMART (name of the grease) : Complete kit including: control unit + lubricant tank with gas generating cells and batteries + protective covers).

LUBER SMART REFILL (name of the grease) : Lubricant tank with gas generating cells and batteries + protective covers).

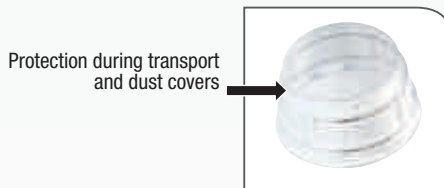
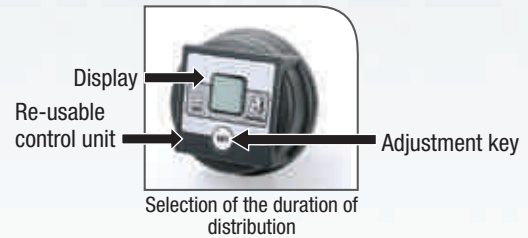
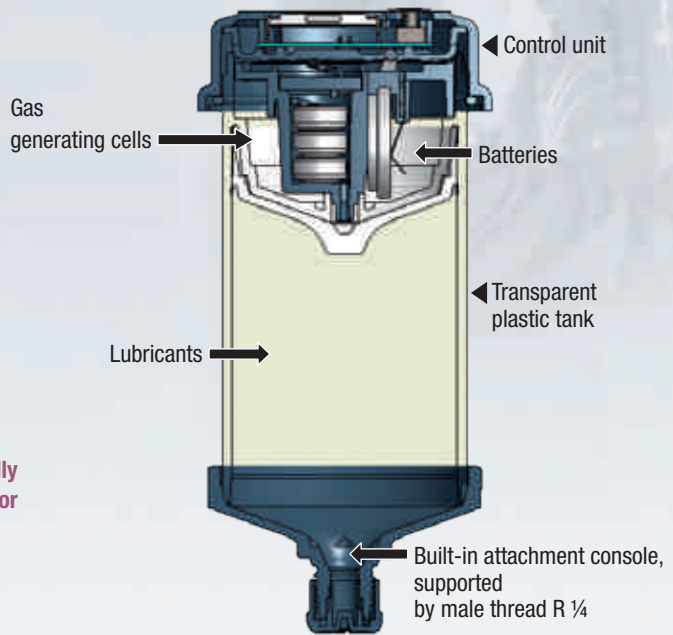

DESIGNATION	PRODUCT	LUBRICANT
LUBER SMART 125 UNIVERSAL+	SMART BOOSTER complete	Grease UNIVERSAL + (General usage)
LUBER SMART REFILL 125 UNIVERSAL+	Refill unit	
LUBER SMART 125 HEAVY DUTY+	SMART BOOSTER complete	Grease HEAVY DUTY + (High loads)
LUBER SMART REFILL 125 HEAVY DUTY+	Refill unit	
LUBER SMART 125 HIGH TEMP MP	SMART BOOSTER complete	Grease HIGH TEMP MP (High temperatures)
LUBER SMART REFILL 125 HIGH TEMP MP	Refill unit	
LUBER SMART 125 VIB	SMART BOOSTER complete	Grease VIB (Vibrations and shocks)
LUBER SMART REFILL 125 VIB	Refill unit	
LUBER SMART 125 FOOD	SMART BOOSTER complete	Grease FOOD (Compatible with food contact)
LUBER SMART REFILL 125 FOOD	Refill unit	
LUBER SMART 125 CHAIN OIL	SMART BOOSTER complete	Oil CHAIN OIL (High performance for chains)
LUBER SMART REFILL 125 CHAIN OIL	Refill unit	

3 / DRIVE BOOSTER 120 & 250

▶ 38

Efficient and environmentally friendly greasing solution.

Easy to set up for applications requiring either direct or remote application of a precise grease dosage to a lubrication point.

DRIVE BOOSTER: the top-of-the-range model for all situations.

A • DESCRIPTION

DRIVE BOOSTER, an electromechanical Automatic Lubricator for extremely precise lubrication, regardless of the temperature, with high service reliability.

Available in 2 sizes, 120 cm³ and 250 cm³, meeting the requirements of most lubrication applications.

Its electromechanically driven control head is characterised by:

- A single button linked to the LCD screen allowing easy adjustment of the discharge duration of the lubricator (1 to 12 months) and also activation of the "draining" function.
- 4 LEDs distributed around the control head providing a clear view of the device status
- A constant and reliable pressure of 6 bar available during the entire duration of lubricant distribution, allowing remote installation up to 5 metres away from the lubrication point.
- A reusable head, helping to protect the environment.

This is the ideal solution for lubrication in dangerous and difficult-to-access areas, and in locations subject to high ambient temperatures or severe vibrations.

B • APPLICATIONS

Designed for the single-point lubrication of plain or rolling element type bearings, open gears, chains, ball screws, linear guide bars, etc. This model is suitable for a wide range of applications and operating conditions, regardless of ambient air pressure and temperature. This model can be installed up to 3 metres from the lubrication point for grease systems and up to 5 metres for oil systems.

C • CHARACTERISTICS AND BENEFITS

<ul style="list-style-type: none"> • Robust electric motor drive. • Easy adjustment via an LCD screen. 	<ul style="list-style-type: none"> • Pressure of 6 bar (distribution up to 5 metres). • Unaffected by vibrations. • High level of reliability: constant grease flow for the entire duration of distribution.
<ul style="list-style-type: none"> • Re-usable. 	<ul style="list-style-type: none"> • Ecological.
<ul style="list-style-type: none"> • Transparent tank in high density polyamide, with reinforced flange. 	<ul style="list-style-type: none"> • Display of grease level.
<ul style="list-style-type: none"> • Fitted with illuminated indicators. 	<ul style="list-style-type: none"> • Indicates the operating status and can be used for quick and remote monitoring.
<ul style="list-style-type: none"> • Compact design. 	<ul style="list-style-type: none"> • Easy to install, even in confined locations.
<ul style="list-style-type: none"> • Lubricator kit comes with all accessories. 	<ul style="list-style-type: none"> • The connector set included means the Lubricator can be immediately fitted to 95% of applications.
<ul style="list-style-type: none"> • Refill unit consisting of a tank of lubricant and battery pack. • Adjustable from 1 to 12 months via a touch-sensitive control unit with a reusable start/stop function and discharge function. 	<ul style="list-style-type: none"> • Service warranty. • Flexible and precise, it reduces operating costs. • The purge function can help clear a blockage.



D • TECHNICAL DATA

Drive: **electromechanical, re-usable**

Power supply: **battery pack**

Capacity: **120 cm³ or 250 cm³**

Max. pressure : **6 bars**

Duration of distribution: **adjustable from 1 to 12 months**

Service temperature: **from -10°C to +60°C**

Available with advanced NTN-SNR greases especially developed for bearings. Contact us for other types of lubricants.

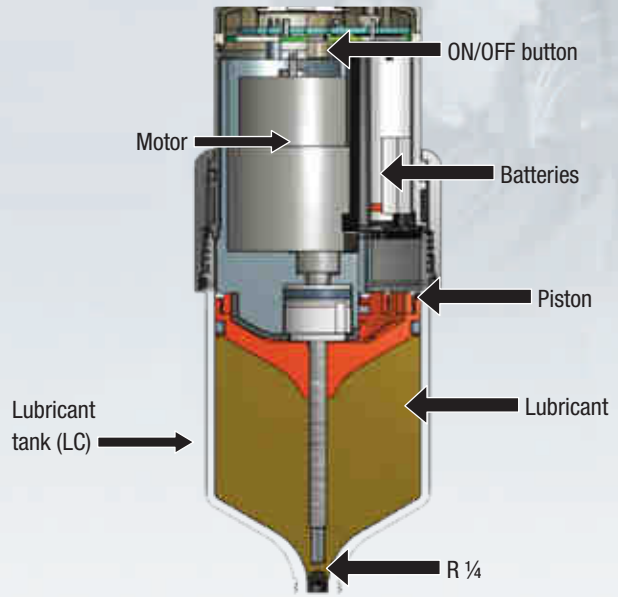

LCD screen with adjustment
(1 to 12 months)
+ discharge function



Protective cover

E • DESIGNATION

LUBER DRIVE KIT (capacity, grease name): Complete Automatic Lubricator kit including: Motor + 120 or 250 cm³ lubricant tank + battery pack + reinforced base + 4 reduction gear connectors.

LUBER DRIVE REFILL (capacity, grease name): Refill including: 120 or 250 cm³ lubricant tank + battery pack.

The complete commercial reference is based on the same logic for other lubricants: UNIVERSAL+, HEAVY DUTY+, HIGH TEMP MP, VIB, FOOD, CHAIN OIL.

DESIGNATION	PRODUCT	LUBRICANT
LUBER DRIVE KIT 120-UNIVERSAL +	DRIVE BOOSTER 120 kit	Grease UNIVERSAL + (General usage)
LUBER DRIVE KIT 250-HEAVY DUTY +	DRIVE BOOSTER 250 kit	Grease HEAVY DUTY + (High loads)
LUBER DRIVE REFILL 120 HIGH TEMP MP	Refill unit 120	Grease HIGH TEMP MP (High temperatures)
LUBER DRIVE REFILL 250 VIB	Refill unit 250	Grease VIB (Vibrations and impacts)

To order:

- a complete 250 cm³ DRIVE BOOSTER kit with the High Temp MP grease,
 - ▶ the reference is LUBER DRIVE KIT 250-HIGH TEMP MP
- a 120 cm³ refill with the HEAVY DUTY + grease,
 - ▶ the reference is LUBER DRIVE REFILL 120 HEAVY DUTY+

4 / ACCESSORIES FOR THE BOOSTER RANGE

Select the most suitable accessories from the NTN-SNR ROULEMENTS range.

Support brackets:

		
DESCRIPTION	Plastic DRIVE / SMART / READY attachment clip	support bracket + insert
PRODUCT NAME	LUBER UNIVERSAL CLIP	LUBER BRACKET

Hose connector:

	
DESCRIPTION	female connector for Booster + 1 hose (Nylon, length 1 m , outer/inner dia.: 8/6 mm) + 1 G1/4 male connector
PRODUCT NAME	LUBER HOSE & CONNECTORS 1 M

Elbows:

		
DESCRIPTION	45° Elbow G1/4 - G1/4	90° Elbow G1/4 - G1/4
PRODUCT NAME	LUBER ANGLE 45 G1/4	LUBER ANGLE 90 G1/4

Adapters:

						
DESCRIPTION	Adapter G1/4 - G1/8	Adapter G1/4 - M6	Adapter G1/4 - M8 x1	Adapter G1/4 - M8 x 1.25	Adapter G1/4 - M10 x1	Adapter G1/4 - M10 x 1.5
PRODUCT NAME	LUBER REDUCER G1/4 - G1/8	LUBER REDUCER G1/4 - M6	LUBER REDUCER G1/4 - M8 x1	LUBER REDUCER G1/4 - M8	LUBER REDUCER G1/4 - M10 x1	LUBER REDUCER G1/4 - M10

Extensions:

		
DESCRIPTION	Extension R1/40 x G1/4 - 30 mm	Extension R1/40 x G1/4 - 75 mm
PRODUCT NAME	LUBER EXTENSION G1/4 30 mm	LUBER EXTENSION G1/4 75 mm



Brushes:

				
DESCRIPTION	Brush dia. 20 G1/4	Brush 40X30 mm G1/4	Brush 60X30 mm G1/4	Brush 100X30 mm G1/4
PRODUCT NAME	LUBER OIL BRUSH diam 20 -G1/4	LUBER OIL BRUSH 40 x 30 -G1/4	LUBER OIL BRUSH 60 x 30 -G1/4	LUBER OIL BRUSH 100 x 30 -G1/4

Drive accessories:

			
DESCRIPTION	Reinforced base G1/4 (copper / plastic)	Protection cap 120 cm ³	Protection cap 250 cm ³
PRODUCT NAME	LUBER PROTECTION BASE	LUBER PROTECTION COVER 120	LUBER PROTECTION COVER 250

Drive accessories:

		Accessories for extreme conditions*	
			
DESCRIPTION	Support base (G1/4 - G1/4) (copper / plastic)	Reinforced base G1/4 (aluminium)	Protective metal cover
PRODUCT NAME	LUBER READY PROTECTION BASE	LUBER READY SUPPORT FLANGE	LUBER READY PROTECTION CAP

* These accessories are sold separately

MULTI POINT

Cost-effective multipoint greasing solution, efficient and easy to set up, allowing the lubrication of 1 to 35 points.

5 / POLIPUMP: Low-cost and easy to implement centralised greasing

Connect it and your central lubrication plant is ready to operate. Simply follow the 4 steps described below:

- 1 **How many points require lubrication?** determine the type of pumping elements required and connect them to the pump
- 2 **Connect the pump** to the power supply
- 3 **Fill the reservoir** using our filling tool kit and the grease of your choice
- 4 **Set up the timer according to your lubricant needs** and the pump is ready to start



A • ADVANTAGES

A cost-effective choice

Treat yourself to a multi-point lubrication system and increase the availability of your equipment while also reducing maintenance costs.

An economical and effective solution

Possibility of lubricating 1 to 35 points with the grease of your choice up to a distance of 20 metres*.

Environmentally friendly and easy to implement

No technical skills are required for the installation of central lubrication system.

Ready for use and easy to recharge, this environmentally friendly pump will continue to help reduce your waste.

B • APPLICATIONS

This lubricating solution was designed for the lubrication of 1 to 35 points in diverse applications. It is mainly used in two distinct sectors:

1. Industry

POLIPUMP can be used for the lubrication of bearings, plain bearings, open gears, chains, ball screws, linear guidance, etc. Stand-alone, it enables you to lubricate up to 35 points over a distance of up to 20 metres*. No recharging required involving specific greases, you can very easily fill your tank with the grease of your choice.

2. Vehicle and chassis (agricultural, building and civil engineering machinery, trucks)

A specific version of POLIPUMP has been designed for applications on building and civil engineering agricultural machinery, trucks, etc. This pump allows the lubrication of up to 35 points while respecting the electrical constraints that are specific to these vehicles.

* Distance subject to conditions: contact us.

C • CHARACTERISTICS AND ADVANTAGES

Sturdy electric motor.	Independent of the temperature and pressure.
Simplified grease distribution system.	No special technical skills required for set up.
Easy programming.	High reliability, constant grease flow over the entire duration of distribution.
Compact pump.	Enables easy integration into your equipment.
Transparent tank.	Visual indication of lubricant level.
Operates with NLGI 00 to 2 grade grease. (Contact us for silicone-based grease)	Using your own lubricant is possible, no refill with special lubricant required.
Optional "flash" tank filling kit.	Solution enabling quick filling of your tank.
6 pumping elements available with different flow rates.	Allows you to more closely match your lubrication requirement.
Full range of accessories available, including connectors and pre-filled hoses.	Our range of unions covers most applications.

D • TECHNICAL DATA

Power supply: **12 VDC or 24 VDC**

2 types of pump: **NRUN for vehicles and IND for the industry**

Capacity: **2-litre tank**

Maximum pressure: **80 bar**

Operating temperature: **-10°C to +60°C**

Grade of the grease that can be used: **NLGI 00 to NLGI 2**

Programming: **from 1 cycle/min to 12 cycles/day (2 cycles/min: for pipe filling only)**

6 types of pumping elements: **0.02, 0.03, 0.04, 0.08, 0.10 and 0.13cc**

Pump available in three versions: **12, 24 or 35 outlets**

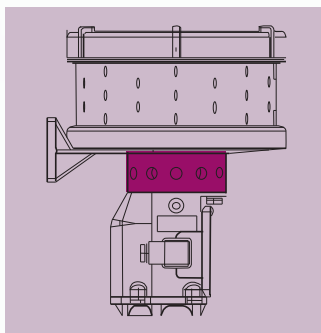

12 outlets

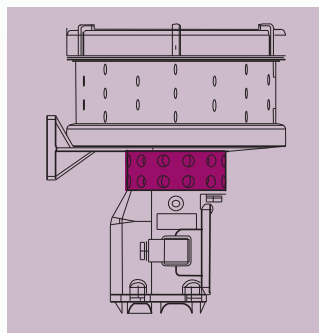

24 outlets

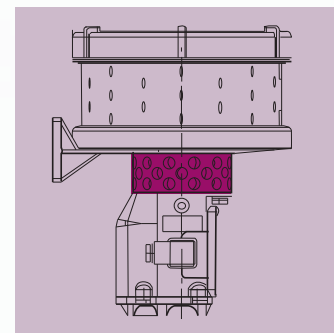

35 outlets

The most important questions to be asked

- How many points do I have to lubricate?
- What is the maximum distance between the two furthest points?
- What type of supply?
- What amount of grease is required for each point to be lubricated?

E • POLIPUMP SOLUTION SELECTION GUIDE

Select the pump and accessories required for your installation from the elements below.

1) SELECTION OF THE PUMP

		DESIGNATION	Numbers of outlet	SAP code	Quantity
POLIPUMP IND For all industrial applications	12 VDC	POLIPUMP-2KG-12 PUM-12VDC-IND_0888270	12	308492	
		POLIPUMP-2KG-24 PUM-12VDC-IND_0888271	24	308496	
		POLIPUMP-2KG-35 PUM-12VDC-IND_0888272	35	308500	
	24 VDC	POLIPUMP-2KG-12 PUM-24VDC-IND_0888273	12	308494	1*
		POLIPUMP-2KG-24 PUM-24VDC-IND_0888274	24	308498	
		POLIPUMP-2KG-35 PUM-24VDC-IND_0888275	35	308502	
POLIPUMP NRUN For heavy duty vehicles (trucks, earth moving equipment...)	12 VDC	POLIPUMP-2KG-12 PUM-12VDC-NRUN_0888276	12	308493	
		POLIPUMP-2KG-24 PUM-12VDC-NRUN_0888277	24	308497	
		POLIPUMP-2KG-35 PUM-12VDC-NRUN_0888278	35	308501	
	24 VDC	POLIPUMP-2KG-12 PUM-24VDC-NRUN_0888279	12	308495	
		POLIPUMP-2KG-24 PUM-24VDC-NRUN_0888280	24	308499	
		POLIPUMP-2KG-35 PUM-24VDC-NRUN_0888281	35	308503	

2) SELECTION OF PUMPING ELEMENTS



DESIGNATION	Color	SAP code	Quantity
PUMPING UNIT 0.02cc - RED_0888451	RED	308508	6*
PUMPING UNIT 0.03cc - GREEN_0888452	GREEN	308509	4*
PUMPING UNIT 0.04cc - YELLOW_0888453	YELLOW	308510	
PUMPING UNIT 0.08cc - BLUE_0888454	BLUE	308511	
PUMPING UNIT 0.10cc - GREY_0888455	GREY	308512	
PUMPING UNIT 0.13cc - BLACK_0888456	BLACK	308513	

3) SELECTION OF CONNECTORS AND HOSE

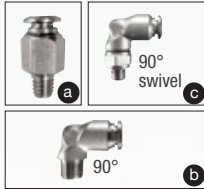

		DESIGNATION	SAP code	Quantity
Connectors		PUSH-IN- M6X1 D4_3084579 a (65 bar max.)	311555	10*
		PUSH-IN-90 M6X1 D4_3084613 b (65 bar max.)	311558	
		PUSH-IN-GIR.90 M8X1 TUBO4_3084731 c (150 bar max.)	311560	
		CONN-ELBOW PUSH-IN M10X1 D4_3084654 b (65 bar max.)	311561	
		SWIVEL CONN-STRAIGHT 90-04-1/8_3084638 c (65 bar max.)	311562	
		STRAIGHTPUSH-IN-CONN 1/8 D4_3084577 a (65 bar max.)	311557	
Hose without grease		TUBE-NYLON 6 4X2 BLACK-25M_5717258 (65 bar max.)	310717	
Hose with grease		TUBE-NYLON6 4X2 BLACK-25M GREASE_5717259 (65 bar max.)	310718	2*

4) GREASE AND GREASE FILLING KIT



DESIGNATION	SAP code	Quantity
KIT CARTRIDGE GREASE FILLING_0888038	308475	1*
FITTING 90° M22 x 1,5 - M/F - 3077222 (for kit cartridge)	370658	
Lub Universal grease	230415	
Lub Heavy duty grease	230422	
Lub High Temp MP grease	467254	
Lub VIB grease	230421	
Lub Food AL grease	297465	1*
Lub Ultra High temp grease	248672	

5) RESERVOIR EXTENSION



DESIGNATION	SAP code	Quantity
Lubso tank segment_888116	326966	1*

*EXAMPLE OF APPLICATION

Industry: Food
Application: Packing machine
Temperature: 25°C
Used grease: FOOD AL
Number of points to lubricate:
 - 4 bearings 22210: 5g (cc)/week
 - 6 bearings 22206: 3.4g (cc)/week

Power supply: 24 VDC
Further information:
 - M6X1 push in fittings
 - distance: 1 bearing 22210 and 22206 up to 10 meters, others up to 3m
 - grease filling kit (cartridge kit + 1 cartridge)







PIECES TO ORDER
Pump: Polipump 24 VDC 12 PUM
Pumping elements:
 a) 5g(cc) / week: 0.03cc with timer setting 24cycles/day**
 b) 3g(cc) / week: 0.02cc with timer setting 24cycles/day**
Connectors: 10 connectors M6x1
Hose: 2 hoses of 25 meters

** Results based on our selection chart available on our website

F • POLIPUMP ACCESSORIES

Select the suitable accessory from the NTN-SNR ROULEMENTS range.

CONNECTIONS:

						
Description	Straight push in union M6X1	Elbow push in union 90° M6X1	Bent push in union 90° rotary M8X1	Bent push in union 90° M10X1	Bent push in union 90° rotary 1/8"	Straight push in union 1/8"
Trade reference	PUSH-IN – M6x1 D4_3084579	PUSH-IN –90 M6x1 D4_3084613	PUSH-IN –GIR.90 M8x1 TUB04_3084731	CONN-ELBOW PUSH-IN M10x1 D4_3084654	SWIVEL CONN-STRAIGHT 90-Ø4-1/8_3084638	STRAIGHTPUSH-IN-CONN 1/8 D4_3084577

HOSES:

		
Description	4X2 nylon hose without grease	Nylon hose pre-filled with NLG100 grease
Trade reference	NYLON TUBE 6 4X2 BLACK-25M_571258	NYLON TUBE 6 4X2 BLACK-25M GREASE_571259

GREASE FILLING KIT AND FITTING 90° M22 X 1,5:

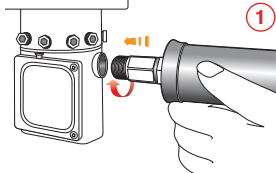
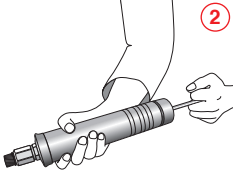
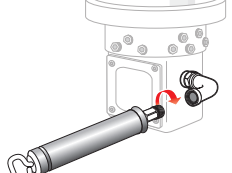
			
Description	Quick POLIPUMP tank filling kit		FITTING 90° M22 x 1,5 to be used with the kit cartridge
Trade reference	KIT CARTRIDGE GREASE FILLING_0888038		FITTING 90° M22 x 1,5 - M/F - 3077222

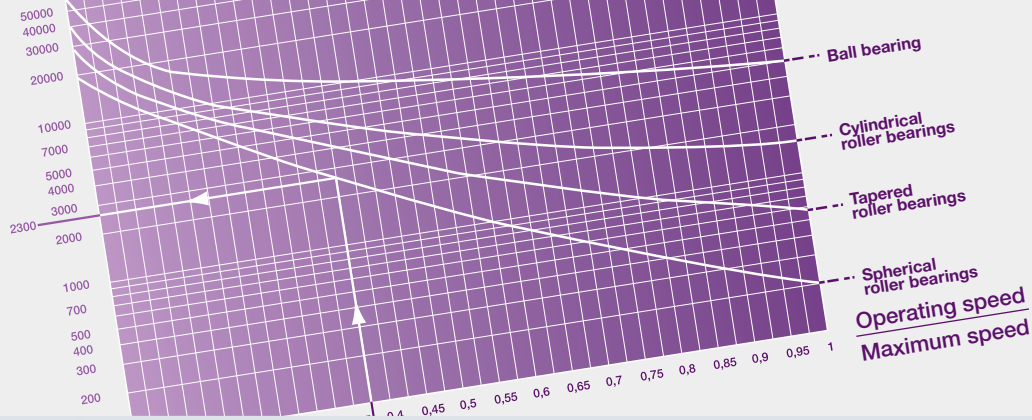

P.30 3. LUBRICATION THEORY AND METHODS

- LUB'SOLUTIONS services 31
- Lubrication requirement design tools 32

3•1 - LUB'SOLUTIONS SERVICES

Do you need assistance with defining your industrial lubrication requirements for your application?
Do you need to design and produce the most suitable lubrication system for your machine?
Do you need an installer to implement or modify a system?
Are you facing operating difficulties with your industrial lubrication system?

LUB'SOLUTIONS by NTN-SNR Experts & Tools is a team primarily of engineers and technicians available to provide support for all your projects or tasks.

Contact us directly at NTN-SNR Experts & Tools for these requirements (tel. +334 5065 3000, web site <https://www.ntn-snr.com/>) or contact us via your dealer or your NTN-SNR sales representative.

3•1.1 - ADVICE TO DEFINE YOUR REQUIREMENTS

Our engineers can assist you in selecting the most appropriate lubrication technology, for your application and its environment, and to design the best performing system for your machine.

In addition, working with NTN-SNR when designing a machine has a significant advantage: Designing the bearings and their lubrication system simultaneously will ensure superior dependability and optimal operation for your industrial unit at an optimised cost.

Modifying existing units

We can assist you with equipping older machines designed without a centralised lubrication system, or existing obsolete systems. LUB SOLUTIONS can determine the nearest or most appropriate equivalent system for your equipment.

3•1.2 - DESIGN AND MANUFACTURING OF MADE-TO-MEASURE SYSTEMS

NTN-SNR designers can provide customised technical and commercial services plus technical documents (block diagrams, lists of parts) based on your specifications.

Once you have approved our proposal, NTN-SNR will then produce your made-to-measure lubrication system.

3•1.3 - INSTALLING LUBRICATION SYSTEMS ON CUSTOMER SITES

NTN-SNR technicians are at your disposal to install your industrial lubrication systems, designed by us, on your machines and on your site.

3•1.4 - AFTER-SALES SERVICE

Even outside of the warranty period, NTN-SNR can provide maintenance and servicing services for industrial lubrication systems. We also offer this service for systems designed by third parties.

3. LUBRICATION THEORY AND METHODS

3•2 - LUBRICATION REQUIREMENT DESIGN TOOLS

SELECTING THE VISCOSITY OF LUBRICANTS (OIL OR GREASE)

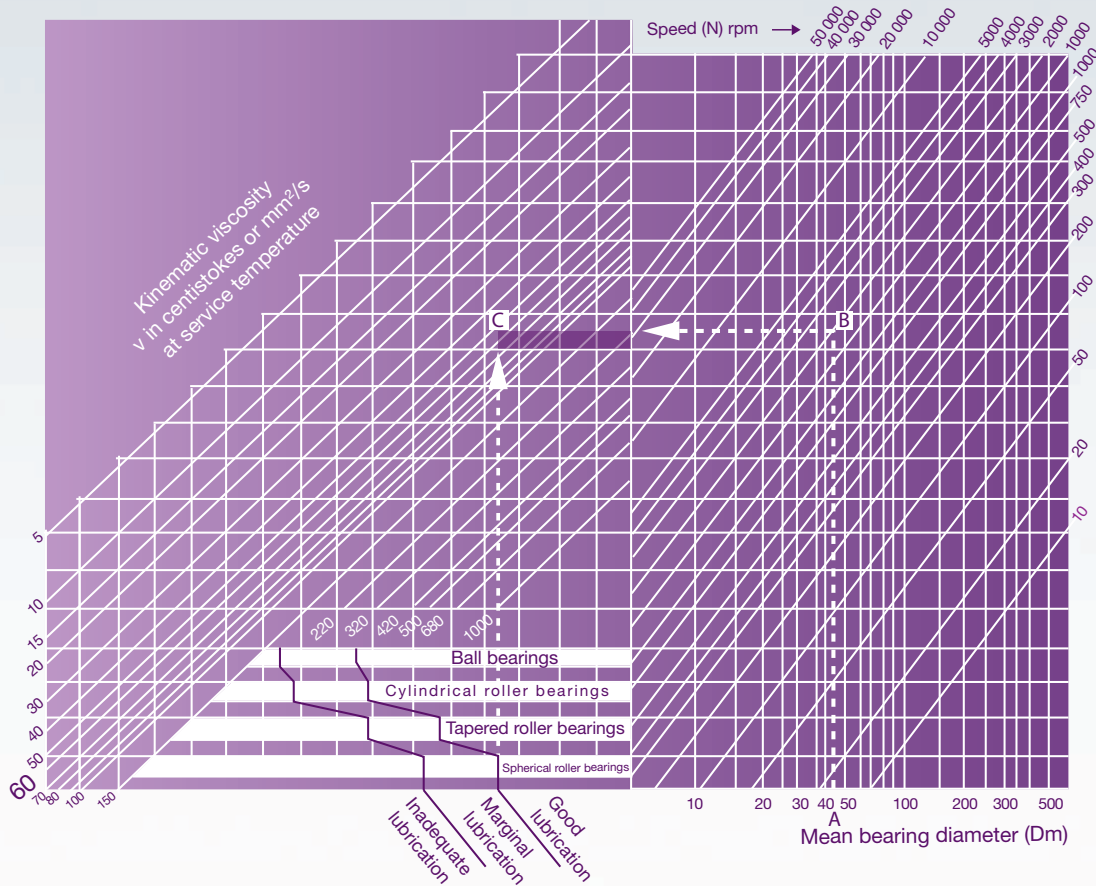

- Determine the mean diameter of the bearing $(A) = (\text{Bore} + \text{outer diameter}) / 2$.
- Find, by following point B on the graph, the intersection with the rotational speed line of the bearing.
- Identify point C, intersection of the horizontal line from B and the vertical line running from the effective lubrication limit per type of bearing.
- Determine the value of the oblique line passing through C (60, in this case).

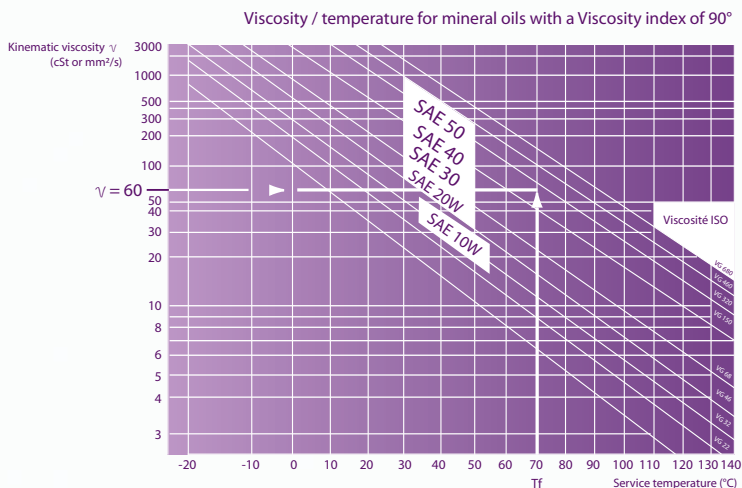

- Then calculate the viscosity of the lubricant to be selected on the basis of the service temperature of the bearing.

Mark the value of calculated basic viscosity on the vertical axis.

Identify the intersection between this value and the service temperature of the bearing.

The target viscosity is the value of the oblique line passing through this intersection. (Approximately SAE 50, i.e. VG 300 in this case).

INITIAL CHARGE OF LUBRICANT AND RELUBRICATION

• OIL LUBRICATION (MINIMUM QUANTITY)

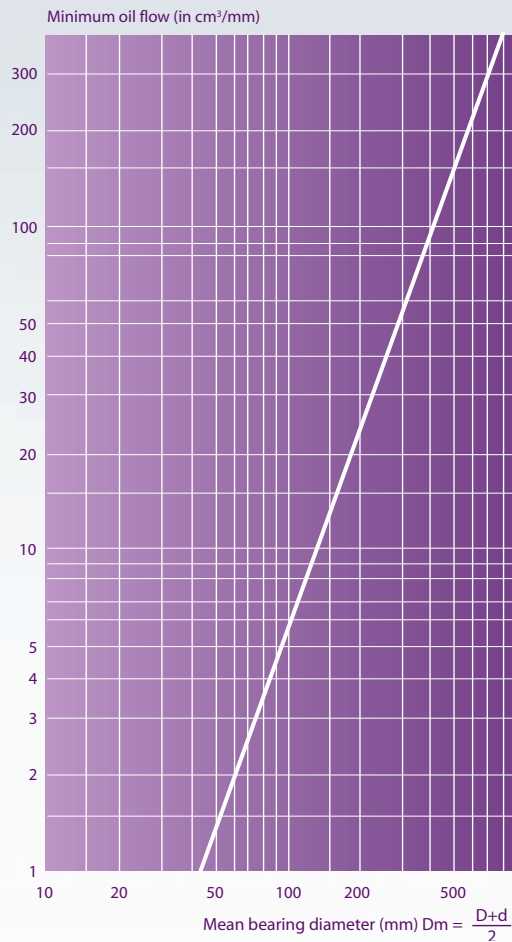

• GREASE LUBRICATION (DOSING)

Excess grease can lead to heating. Grease must occupy 20 to 30% of free volume within the bearing.

Formula to calculate the weight of grease required:
 $G = 0.005 D.B$

G=Gram (or cm³)

D=Outer diameter of the bearing in mm

B= Width of the bearing in mm

Exceptions:

- The quantity of grease may be increased by 20% for bearings equipped with a grease evacuation hole.
- A bearing rotating at a very low speed can be filled completely.

• FREQUENCY OF RELUBRICATION

Basic frequency in hours

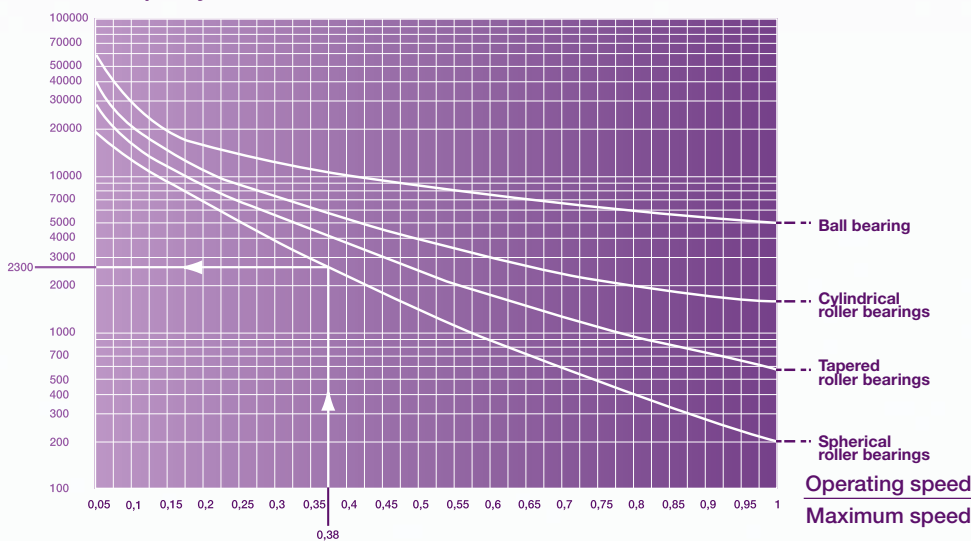

The basic frequency (F_b) of relubrication depends on the type of bearing and the ratio of operating speed to the maximum speed indicated in the bearing characteristics.

3. LUBRICATION THEORY AND METHODS

This basic frequency must be corrected by the following coefficients on the basis of the specific conditions of the environment of the mechanism (dust, humidity, impact, vibrations, vertical axis, service temperature, etc.) according to the formula: $F_c = F_b \cdot T_e \cdot T_a \cdot T_t$.

Conditions	Environment	Applications	Temperature		
	Dust Humidity Condensation	With shocks Vibrations Vertical axis	Level	For standard grease	For high temperature grease
Coefficients	T_e	T_a		T_t	T_t
Mean	0.7 to 0.9	0.7 to 0.9	75°C	0.7 to 0.9	-
High	0.4 to 0.7	0.4 to 0.7	75°C to 85 °C	0.4 to 0.7	0.7 to 0.9
Very high	0.1 to 0.4	0.1 to 0.4	85°C to 125 °C	0.1 to 0.4	0.4 to 0.7
	-	-	130°C to 170 °C	-	0.1 to 0.4

Example: a 22 212EA bearing, lubricated with standard grease, rotating at 1500 rpm in a dusty environment, at 90°C, without any other operating restrictions:

22212 = Spherical roller bearing

Max. speed = 3900 rpm

Operating speed = 1500 rpm

$$\frac{V_{\text{operating}} = 1500 \text{ tr/mn}}{V_{\text{speed}} = 3900 \text{ tr/mn}} = \frac{1500}{3900} = 0.38 \dots \rightarrow \text{Basic frequency } F_b = 2300 \text{ H}$$

$T_e = 0.5 \dots \rightarrow$ dust
 $T_a = 0.9 \dots \rightarrow$ normal
 $T_t = 0.3 \dots \rightarrow$ 90°C

• WEIGHT OF THE GREASE TO BE REPLACED

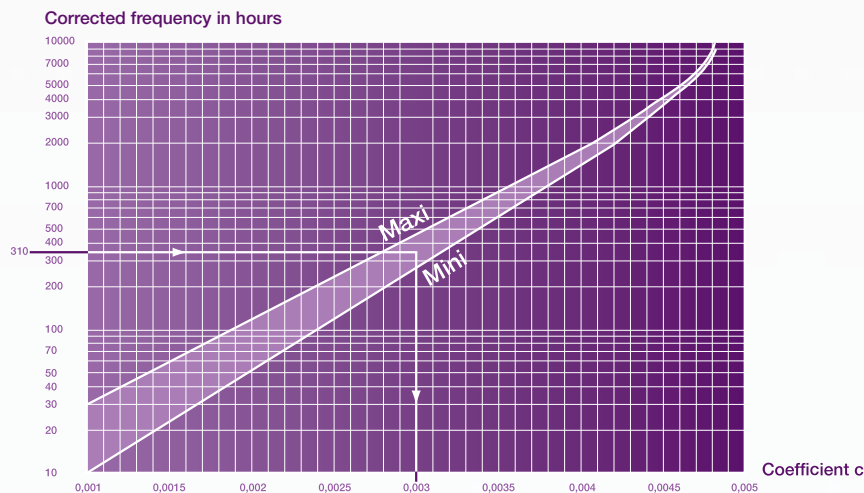

This corrected frequency can be used to determine the weight of grease to be added, depending on:

- bearing width B,
- outer diameter D,
- coefficient c taken from the graph below based on the formula $P = D \times B \times c$

Example :

for bearing 22 121 (roller bearings)

P= weight of the grease

Add approximately 9 grams every 310 hours of operation

An initial approximation gives the following values:

FLOW ADJUSTMENT PARAMETERS

Shaft diameter	Frequency of manual lubrication (1 pump stroke = 0,5 cm³)	Quantity per day	Frequency of replacement of the automatic lubricator
100 to 120 mm	8 pump strokes per day	3 to 4 cm³	1 month
80 to 100 mm	4 pump strokes per day	2 cm³	2 months
65 to 80 mm	16 to 20 pump strokes per week	1.5 cm³	3 months
50 to 65 mm	16 to 20 pump strokes every 15 days	0.7 cm³	6 months
< 50 mm	16 to 20 pump strokes per month	0.3 cm³	12 months

LUBSO PUMPING

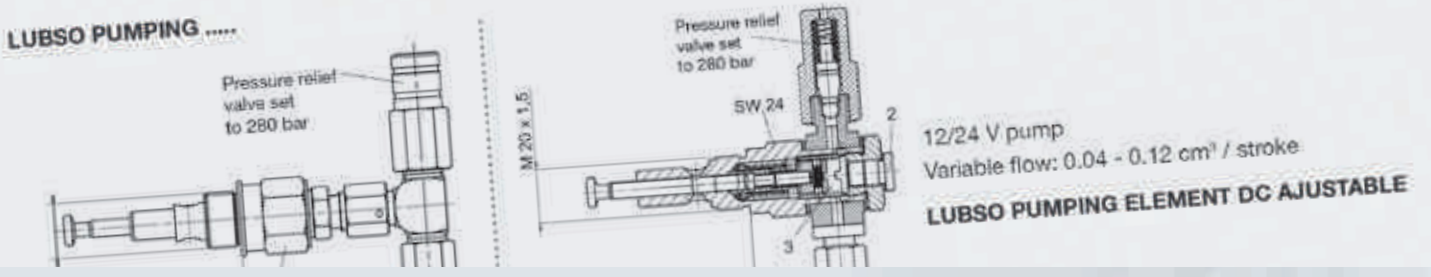

P.35 4. PRODUCT TECHNICAL DATA

4. TECHNICAL DATA FOR PRODUCTS

Reference : LUB GREASE GUN SET

> P. 16

TECHNICAL DATA

Grease gun designed for use with 400 g cartridges or filled directly with grease, with a drain and filler valve. This gun is compatible with standard grease cartridges, particularly NTN-SNR LUB grease cartridges.

- Material: strong sheet steel
- Weight: 1 130 g with rigid hose and nozzle
- Rigid steel, 150 mm
- Hydraulic type steel nozzle, 3 jaws, with flat bar (10x100 thread)

Capacity	Flow	Service pressure	Maximum pressure
500 cm ³	0,50 cm ³	180 bar	345 bar

- Lubrication accessories supplied with the gun: a bichromate zinc-plated steel extension (M10 x 100 thread).
- Option: two plastic nozzles with a standard thread.

SINGLE-POINT BOOSTER AUTOMATIC LUBRICATOR







LUBER READY (NAME OF THE LUBRICANT)

> P. 18

Capacity	60 cm ³ or 125 cm ³
Duration of distribution	Adjustable from 1 to 12 months
Ambiant temperature range	From -20°C to +60°C
Maximum service pressure	5 bar
Drive	Electrochemical reaction
Maximum distance allowable between the automatic lubricator and the lubricant point	Oil 1500mm and inner diameter 6mm Grease 1000mm and inner 6mm*
Intrinsic safety certification	I M1 Ex ia I II 1G Ex ia IIC T6 II 1D Ex iaD 20 T 85°C
Recommended storage temperature	20°C
Maximum storage time and expiry dates	Max.1 year in storage (grease) + 1 year in service
Weight (with lubricant)	READY BOOSTER 60 Approx. 145 g READY BOOSTER 125 Approx. 260 g

* The maximum length of the lubricant line depends on ambient temperature, the type of grease and back pressure generated by the application.

DURATION OF THE DISCHARGE OF THE READY BOOSTER AT 20°C

	 1 month	 3 months	 6 months	 9 months	 12 months
 -20°C	2	5	10	13	15
0°C	1.3	3.8	7.2	11	13
+20°C	1	3	6	9	12
+40°C	0.8	2.5	5.2	7.5	10
+60°C	0.6	2	4	-	-

Data based on laboratory back pressure tests and using grade 2 greases.
Possible residue for a temperature > 40°C or an emptying period of > 6 months.

Adjustment of flow at 20°C (grease)

Output selector (months)		1	2	3	4	5	6	7	8	9...	...12
Lubricant / day (cm³)	60cc	2.0	1.0	0.7	0.5	0.4	0.3	0.3	0.3	0.2	0.2
	125cc	4.2	2.1	1.4	1.0	0.8	0.7	0.6	0.5	0.5	0.4
Lubricant / week (cm³)	60cc	14.0	7.0	4.7	3.5	2.8	2.3	2.0	1.8	1.6	1.6
	125cc	29.2	14.6	9.7	7.3	5.8	4.9	4.2	3.6	3.2	2.6
Pump strokes / day	60cc	60	30	20	15	12	10	8.5	7.5	6.6	5
	125cc	125	62.5	41.6	31.2	25	20.8	17.8	15.6	13.8	10.4
Pump strokes / week	60cc	9-11	5	3	2-3	2	1-2	<1.5	<1.5	1	<1
	125cc	60	29 - 30	19 - 20	14 - 15	11 - 12	9 - 10	8 - 9	7 - 8	6 - 7	5 - 6

1 pump stroke of the grease gun distributes: 0.5 cm³/piston displacement.

LUBER SMART 125 (NAME OF THE GREASE)

> P. 20

Complete kit (control unit + lubricant tank with gas cells and batteries + plastic cover).

LUBER SMART REFILL 125 (NAME OF THE GREASE)

> P. 21

Lubricant tank with gas cells and batteries + plastic cover.

Capacity	125 cm³
Duration of distribution	Adjustable from 1 to 12 months (in whole months)
Ambient temperature interval	from -20°C to +60°C
Maximum service pressure	6 bar
Drive	Gas generation cell with electronic temperature compensation
Maximum distance allowable between the automatic lubricator and the lubrication point	Oil 1500 mm and inner diameter 4 mm Grease 1000 mm and inner diameter 6 mm*
Intrinsic safety certification	I M1 Ex ia I Ma II 2G Ex ia IIC T4 Gb II 2D Ex ia IIIC T135°C Db
Protection index	IP 65
Recommended storage temperature	20°C
Maximum storage time and expiry dates	Max. 2 years in storage (grease) + 1 year in service **
Weight (with lubricant)	Approx. 280 g including the electronic unit: 40 g

* 1000 mm with a min. inner diameter of 10 mm. The maximum length of the lubricant line depends on ambient temperature, the type of grease and back pressure generated by the application.

** The electronic control unit is reusable and not concerned by this limit.



Adjustment of flow

Flow/Adjustment (month)

Setting (in months)	1	2	3	4	5	6	7	8	9...	...12
Lubricant / day (cm³)	4	2	1.4	1.1	0.9	0.7	0.6	0.5	0.5	0.4
Lubricant / week (cm³)	29	14.5	10.1	7.6	6.1	5.1	4.3	3.8	3.4	2.7
Pump strokes / day	8 to 9	4 to 5	2 to 3	2 to 3	2	1 to 2	1	1	1	< 1
Pump strokes / week	60 to 62	30 to 32	20 to 21	15 to 16	12 to 13	10 to 11	8 to 9	7 to 8	6 to 7	5 to 6

1 pump stroke (grease gun) distributes: 0.5 cm³ / piston displacement.

4. TECHNICAL DATA FOR PRODUCTS

LUBER DRIVE KIT (CAPACITY, NAME OF THE LUBRICANT)

> Pag. 22

Complete kit (Motor + 120 or 250 cm³ lubricant tank + battery pack + reinforced base + 4 adapters).

LUBER DRIVE REFILL (CAPACITY, NAME OF THE LUBRICANT)

> Pag. 23

120 or 250 cm³ lubricant tank + battery pack.

Capacity	120 cm ³ or 250 cm ³	
Duration of distribution	Adjustable from 1 to 12 months	
Ambient temperature range	From -10°C to +60°C	
Maximum service pressure	6 bar	
Drive	Electromechanical	
Maximum distance allowable between the automatic lubricator and the lubrication point	Oil 5 metres and inner diameter 4 mm Grease 5 metres and inner diameter 6 mm	
Status indicators	In good working order, operational, empty, defective	
Recommended storage temperature	20°C	
Maximum storage time	1 year of storage (grease) + 1 year of service	
Battery pack	3 x 1,5 VAA	
Adapters included in the kit	Adapter G1/4 – G1/8 Adapter G1/4 – M8 X 1	Adapter G1/4 – M6 Adapter G1/4 – M10 X 1
Weight (with lubricant)	DRIVE BOOSTER 120 DRIVE BOOSTER 250	Approx. 500 g Approx. 650 g



Type	Volume (cm ³)	Diameter D (mm)	Total length L (mm)
REFILL 120	120	75	178
REFILL 250	250	75	228



Drive 120 CC										
Setting / months	1	2	3	4	5	6	7	8	9 12
Lubricant / day	4.0	2.0	1.3	1.0	0.8	0.7	0.6	0.5	0.4	0.4
Lubricant / 100 hours	16.7	8.3	5.6	4.2	3.3	2.8	2.4	2.1	1.9	1.5
Lubricant / week	28.0	14.0	9.3	7.0	5.6	4.7	4.0	3.5	3.1	2.5
Pump strokes / day	8	4	2.6	2	1.6	1.4	1.2	1	0.8	0.8
Pump strokes / day	33	16	13	8.5	6.5	5.6	5	4	4	3
Pump strokes / week	56	28	18.5	14	13	9.5	8	7	6	5

Drive 250 CC										
Parametering/months	1	2	3	4	5	6	7	8	9 12
Lubricant / day	8.3	4.2	2.8	2.1	1.7	1.4	1.2	1.0	0.9	0.7
Lubricant / 100 hours	34.7	17.4	11.6	8.7	6.9	5.8	5.0	4.3	3.9	3.1
Lubricant / week	58.3	29.2	19.4	14.6	11.7	9.7	8.3	7.3	6.5	5.2
Pump strokes / day	17	8	6	4	3.5	3	2.5	2	2	1.5
Pump strokes / 100 hours	69	35	23	17.5	14	11.5	10	8.5	8	6
Pump strokes / week	116	58	39	29	23.5	19	16.5	14.5	13	10.5

1 pump stroke (grease gun) distributes: 0.5 cm³/ piston displacement.

4. TECHNICAL DATA FOR PRODUCTS

POLIPUMP-2KG-(12-24-35) PUM-(12-24) VDC-(IND-NRUN)

26

An electric pump with integrated tank, POLIPUMP is designed to be used with pumping units.

The IND model is designed for industrial applications.

The NRUN model is designed for industrial vehicles (trucks, building and civil engineering works and farming vehicles).

1) TECHNICAL CHARACTERISTICS

Pumping system	Single-acting pumping elements with cam activation		
Drive assembly	CC motor with reduction gear		
Electrical supply	12 VDC	24 VDC	
Electronic protection threshold for motor overload	0.6 A		
Net weight	3.4 kg (2.2 lb)		
Number of outputs/max/version	12 – 24 – 35		
Connection of pumping elements	Instantaneous for Ø 4 (5/32 inches)		
Nominal output per pumping element	0.02 cm ³ /stroke 0.03 cm ³ /stroke 0.04 cm ³ /stroke 0.08 cm ³ /stroke 0.10 cm ³ /stroke 0.13 cm ³ /stroke	RED GREEN YELLOW BLUE GREY BLACK	(1 notch) (2 notches) (3 notches) (4 notches) (5 notches) (6 notches)
Max. discharge pressure	80 bar		
Tank capacity	Standard model	2 L (0.53 gallons)	
	Model with follower plate	4 L (1.06 gallons)	
Compatible grease (except silicone-based grease)	NLGI00 to NLGI2		
Operating temperature	-10°C to +60°C (+14°F to +140°F)		
Storage temperature	-20°C to +80°C (-4°F to +176°F)		
Sound level	< 70 dB (A)		
Minimum level indication	Hall effect sensor		
CONTROL PANEL CHARACTERISTICS			
Electrical supply	12 VDC – 24 VDC		
Operating temperature	-10°C to +60°C (+14°F to +140°F)		
Storage temperature	-20°C to +80°C (-4°F to +176°F)		
Characteristics	<ul style="list-style-type: none"> • Protection against motor overloads • Input power supply protection • Remote alarm signal • End of cycle control sensor 		
Protection level	IP 65		
Relay alarm contact	NC (open during alarm) – I _{max} 5 A - V _{max} 250 V – P _{max} 60 W		

2) INSTALLATION OF PUMPING ELEMENTS AND PLUGS

The pumping elements are not supplied with the pump. They must be ordered separately depending on the number of lubrication points required and then installed prior to operation.

Each pumping element includes a colour code corresponding to the discharge volume and is simply be screwed into the appropriate outlet port. All unused ports must be blanked with the supplied plugs.

Positioning of pumping elements

Select a location for the first pumping element and then distribute the other elements in the outlet header ports according to the instructions in the table below and in the diagram (fig.1).

Number of outlets used	POSITION OF PUMPING ELEMENTS	Number of outlets used	POSITION OF PUMPING ELEMENTS	Number of outlets used	POSITION OF PUMPING ELEMENTS
Row 1		Row 2		Row 3	
1	1	13	13	25	25
2	1-7	14	13-19	26	25-31
3	1-5-9	15	13-17-21	27	25-29-33
4	1-4-7-10	16	13-16-19-22	28	25-28-31-34
5	1-2-4-7-10	17	13-14-16-19-22	29	25-26-28-31-34
6	1-3-5-7-9-11	18	13-15-17-19-21-23	30	25-27-29-31-33-35
7	1-2-4-5-7-9-11	19	13-14-16-17-19-21-23	31	25-26-28-29-31-33-35
8	1-2-4-5-7-8-10-11	20	13-14-16-17-19-20-22-23	32	25-26-28-29-31-32-34-35
9	1-2-3-5-6-7-9-10-11	21	13-14-15-17-18-19-21-22-23	33	25-26-27-29-30-31-33-34-35
10	1-2-3-4-5-6-7-9-10-11	22	13-14-15-16-17-18-19-21-22-23	34	25-26-27-28-29-30-31-33-34-35
11	1-2-3-4-5-6-7-8-9-10-11	23	13-14-15-16-17-18-19-20-21-22-23	35	25-26-27-28-29-30-31-32-33-34-35
12	1-2-3-4-5-6-7-8-9-10-11-12	24	13-14-15-16-17-18-19-20-21-22-23-24		

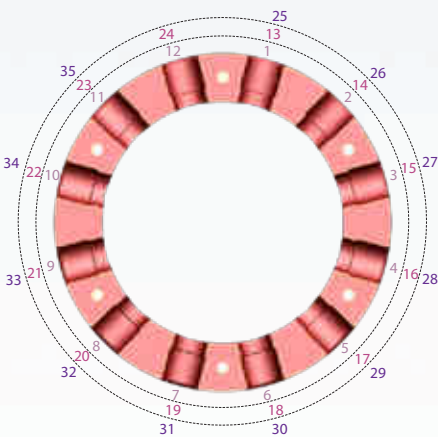
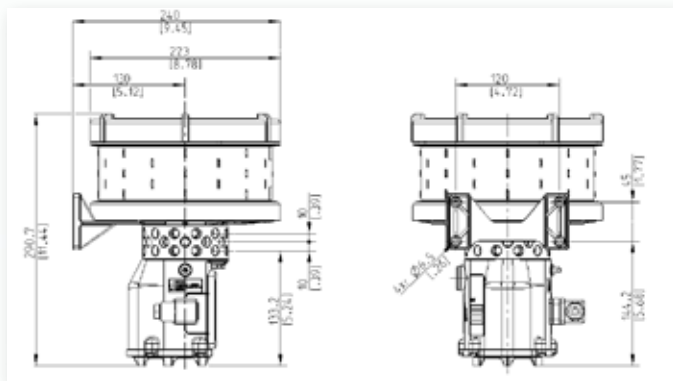

Fig.1: positioning of pumping elements depending on the number of outlets used.

Tighten the pumping elements (12 mm wrench) and the plugs (6 mm Allen key) applying a torque of 10 Nm.

3) ELECTRICAL CONNECTION DIAGRAM

Dimensions



NRUN: model designed for industrial vehicles. The connection with general activation (NRUN) allows the use of the pump with the machine in closed-loop control. The pump operates only if the activation signal is present, otherwise it remains in standby mode; the external activation signal is a standard +5V logical signal.

12 VDC-IND

- 1 = 12VDC +
- 2 = ALARM NO out
- 3 = ALARM COM out
- ⊥ = 12VDC -

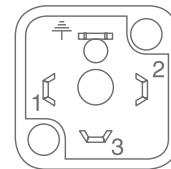

24 VDC-IND

- 1 = 24VDC +
- 2 = ALARM NO out
- 3 = ALARM COM out
- ⊥ = 24VDC -

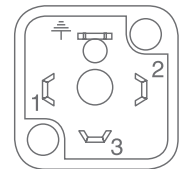

12 VDC-NRUN

- 1 = 12VDC +
- 2 = NRUN in
- 3 = ALARM out
- ⊥ = 12VDC -

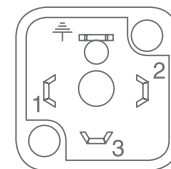

24 VDC-NRUN

- 1 = 24VDC +
- 2 = NRUN in
- 3 = ALARM out
- ⊥ = 24VDC -

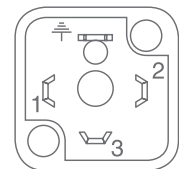



NOTES







You can increase the operational effectiveness of your activity with our «field» experts by:

- Reducing your maintenance costs
- Improving the quality of your operations
- Optimising the service life of your equipment

NTN-SNR can:

- Provide training on practical and theoretical aspects
- Provide technical assistance
- Demonstrate maintenance products
- Renovate bearings and machine tool spindles
- Provide rapid bearing diagnostics
- Rent maintenance tools
- Audit your industrial maintenance organisation

Distributed by:

This document is the exclusive property of NTN-SNR ROULEMENTS. Any total or partial reproduction hereof without the prior consent of NTN-SNR ROULEMENTS is strictly prohibited. Legal action may be brought against anyone breaching the terms of this paragraph.

NTN-SNR ROULEMENTS shall not be held liable for any errors or omissions that may have crept into this document despite the care taken in drafting it. Due to our policy of continuous research and development, we reserve the right to make changes without notice to all or part of the products and specifications mentioned in this document.

© NTN-SNR ROULEMENTS, international copyright 2020.